

D/F HANDBOOK  
FOR  
WIRELESS OPERATORS

also by  
**W. E. CROOK**

**ELEMENTARY  
HANDBOOK *for*  
WIRELESS OPERATORS**

An R.A.F. instructor says of this book: "I was very pleased to read this interesting book. I consider the work of great practical scope, and an invaluable guide to all tradesmen in this important part of the service." 4s. net.

**ELEMENTARY  
MATHEMATICS *for*  
WIRELESS OPERATORS**

An R.A.F. man says of this book: "The simplicity in which the normally complicated and confusing equations are portrayed will beyond doubt encourage and assist not only those in training but those who are already qualified Wireless Operators. I should like to take this opportunity to congratulate the author and yourselves on presenting to the public this excellent handbook." 3s. 6d. net.

**ELECTRICITY  
IN AIRCRAFT**

("X" Licence)

"Journal of the Royal Aeronautical Society" says: "The author is to be congratulated on the simplicity and conciseness of his text. The book can be thoroughly recommended." 5s. net.

**WIRELESS  
TELEGRAPHY**

**Notes for Students**

"Electrical Engineer" says: "Recommended to serious students of wireless telegraphy, and would also be useful as a reference book to the young experimenter." 7s. 6d. net.

**WIRELESS  
OPERATING**

**Simply Explained**

Gives a clear and interesting picture of the wireless operator in action—what he has to do and how he does it. 6d. net.

*Write for a Complete List of  
Pitman's Aeronautical Books,  
post free from*

39 Parker Street, Kingsway, W.C.2

**D/F HANDBOOK  
FOR  
WIRELESS OPERATORS**

BY

**W. E. CROOK**

A.M.I.E.E., A.F.R.Ae.S.

AUTHOR OF

"WIRELESS TELEGRAPHY"; "ELECTRICITY IN AIRCRAFT" ("X" LICENCE)  
"ELEMENTARY MATHEMATICS FOR WIRELESS OPERATORS"  
"ELEMENTARY HANDBOOK FOR WIRELESS OPERATORS"  
"WIRELESS OPERATING SIMPLY EXPLAINED"

*SECOND EDITION*



LONDON  
SIR ISAAC PITMAN & SONS, LTD.

1942

*First Edition, 1941*  
*Second Edition, 1942*

SIR ISAAC PITMAN & SONS, LTD.  
PITMAN HOUSE, PARKER STREET, KINGSWAY, LONDON, W.C.2  
THE PITMAN PRESS, BATH  
PITMAN HOUSE, LITTLE COLLINS STREET, MELBOURNE  
UNITEERS BUILDING, RIVER VALLEY ROAD, SINGAPORE  
27 BECKETTS BUILDINGS, PRESIDENT STREET, JOHANNESBURG  
ASSOCIATED COMPANIES  
PITMAN PUBLISHING CORPORATION  
2 WEST 45TH STREET, NEW YORK  
205 WEST MONROE STREET, CHICAGO  
SIR ISAAC PITMAN & SONS (CANADA), LTD.  
(INCORPORATING THE COMMERCIAL TEXT BOOK COMPANY)  
PITMAN HOUSE, 381-383 CHURCH STREET, TORONTO

## PREFACE TO SECOND EDITION

IN preparing the second edition of this work, it was felt desirable to extend its scope and cover the interests of the aircraft operator.

A chapter on Aircraft D/F has accordingly been added, and it is hoped that the additional information will enable wireless operators who may work in the air to use their D/F apparatus with confidence.

The reception accorded to the first edition has been more than gratifying, and the author wishes to take this opportunity of thanking all those who have written expressing appreciation.

## PREFACE TO FIRST EDITION

IT has for some time been recognized that the wireless operator employed at a D/F station must be regarded as a specialist, and experience has shown the necessity for specialized training of those who are to undertake this work.

Although most general treatises on radio contain some information about D/F, it is felt that a small book devoted exclusively to the subject will be particularly useful to wireless operators who are already working on D/F or who wish to volunteer for this branch when their training is completed.

In the following pages, a knowledge of elementary radio theory has been assumed, but a strictly practical treatment has been maintained as far as possible.

Specific D/F apparatus is not referred to because the variations in detail are very wide and nothing would be gained by describing one or two actual sets which will inevitably be obsolete in a comparatively short time. The aim is rather to give the student such knowledge of the principles of all D/F apparatus and its operation as will enable him to view any D/F station through the specialist's eye, and consequently to take up his duties with the minimum of delay necessary to master local details.

## CONTENTS

| CHAP.                                | PAGE |
|--------------------------------------|------|
| PREFACE TO SECOND EDITION . . . . .  | v    |
| PREFACE TO FIRST EDITION . . . . .   | v    |
| I. GENERAL VIEW OF D/F . . . . .     | 1    |
| II. ROTATING FRAME D/F . . . . .     | 6    |
| III. BELLINI-TOSI D/F . . . . .      | 19   |
| IV. SENSING AND FIXING . . . . .     | 25   |
| V. ERRORS IN D/F . . . . .           | 36   |
| VI. SITING AND CALIBRATION . . . . . | 56   |
| VII. AIRCRAFT D/F . . . . .          | 64   |
| INDEX . . . . .                      | 85   |

# D/F HANDBOOK FOR WIRELESS OPERATORS

## CHAPTER I

### GENERAL VIEW OF D/F

THE practical application of D/F is an aid to marine and air navigation, and it is with this aspect that the D/F operator is concerned. In the absence of radio communication, a ship or aircraft can determine and keep track of its position either by (*a*) dead-reckoning (D.R.) navigation, or (*b*) astronomical observations. D.R. navigation means the recording of the path followed by observing compass course, speed and time, and in the case of aircraft it may easily become inaccurate owing to unknown or changing winds and the high speeds of modern aircraft, more especially when the aircraft's task involves frequent changes of course.

Astronomical observations are obviously dependent upon weather conditions; the equipment required is suitable mainly for large aircraft and, in any case, astro-navigation is only applicable to really long flights. These difficulties are comparatively unimportant in ships because their speed is insignificant compared to that of an aircraft and the duration of the voyage enormously greater.

Wireless D/F used by a ship is therefore more in the nature of a check on the older methods of navigation—valuable and universally employed, but not perhaps imperative.

With aircraft, the speeds involved and the difficulties of applying D.R. navigation have resulted in radio D/F taking first place in navigational methods, and the organization of a modern airport has become dependent upon the existence of a D/F service.

Directional properties can be vested in either a transmitter or a receiver, and in both cases are determined entirely by the design of the aerial system and the circuits immediately associated with it. The bulk of D/F work is carried out by means of directional reception and there are two methods available—

1. A fixed transmitter giving all-round (non-directional) radiation. A directional aerial system on the mobile station, i.e. the ship or aircraft.
2. An all-round transmitter on the ship or aircraft. A fixed D/F station ashore, for example at the airport.

Practically all ships are fitted with D/F receivers, and the fixed transmitters necessary for Method 1 are provided in the form of

coast beacons. These exist all over the world and are merely automatic all-round transmitters which radiate at frequent intervals and identify themselves by the use of call-signs. Full details of all such beacons, their latitude and longitude, call-signs, times of transmission, frequency, etc., can be found in the list of "Stations Performing Special Services," published by the International Bureau of the Telegraph Union, Berne. That book is always carried on ships and in some cases on aircraft. Any broadcasting station can, of course, also be used in this way provided the exact position of the transmitter is known. The chief advantages of this method are that the ship or aircraft does its own D/F and is to that extent independent of any ground organization. In addition, any number of ships or aircraft can carry out D/F simultaneously because they do not have to transmit during the process.

In the case of aircraft or very small ships the necessity for carrying special D/F apparatus is a point against the method, but a much more serious disadvantage with aircraft is the fact that ground control is lost. The speed of aircraft is again the major consideration, because when a number of aircraft are converging on an airport in thick weather, the risk of collision becomes very real, with the result that communication between aircraft and ground, and control of aircraft movements by the airport authorities are imperative in the interests of safety.

Method 2 involves the erection of D/F stations of a permanent nature on the ground, each station having its own transmitter for communicating with the ship or aircraft requiring D/F service. Two-way communication is thus involved which overcomes the objection to Method 1 for aircraft. In addition, it is somewhat easier to obtain precision in ground D/F stations than in D/F apparatus in ships or aircraft, particularly the latter.

From this short general review it will be seen that most marine wireless operators will have occasion to use D/F apparatus, a fair proportion of air operators will do so, and all of them will from time to time make use of ground D/F stations when the navigating officer requires it. Operators employed on ground D/F stations, of course, do little except D/F and, as mentioned in the Preface, must be considered specialists in their work.

**Bearings.** The direction of one point from another must be stated with reference to some fixed datum line, and this is universally taken as the direction of True North.

A bearing is thus specified as the angle made by the line joining the two stations with the True North line (Meridian) passing through one of them. This angle can clearly have any value between  $0^\circ$  and  $360^\circ$ , and the mutual bearings of two stations are reciprocal, i.e. they differ by  $180^\circ$ .\*

For example, in Fig. 1, if  $A$  is due west of  $B$ , the bearing of  $A$  from

\* Since the Earth is approximately a sphere, this is strictly true only for stations which lie on the same meridian, i.e. north and south of each other.

$B$  is  $270^\circ$ , and the bearing of  $B$  from  $A$  is  $90^\circ$ . Similarly, if the bearing of  $D$  from  $C$  is  $50^\circ$ , the bearing of  $C$  from  $D$  is  $230^\circ$ .

*True North* means the direction of the meridian and all meridians pass through the North Pole of the Earth, the North Pole being one end of the Earth's axis of rotation.

*Magnetic North* means the direction in which a compass needle points, which is towards the Earth's Magnetic North Pole.

Magnetic North and True North are not always coincident, and the angular difference in their directions from any particular place

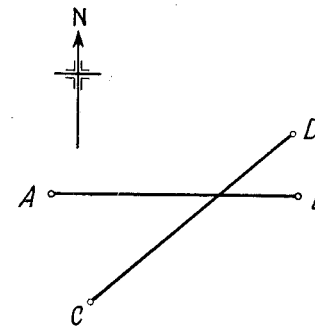

FIG. 1

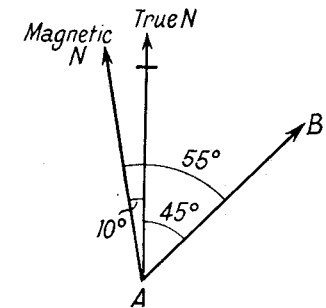

FIG. 2

is called the *Magnetic Variation* at that place. This itself is not constant but changes slowly at the rate of a few minutes of arc per year. Local magnetic variation can be found from an Ordnance Survey map, or from an Admiralty Chart in the case of positions at sea.

Thus there are three kinds of bearings with which a D/F operator is concerned—

1. *True Bearings*, reckoned from True North. The D/F scale is almost invariably arranged to read true bearings.

2. *Magnetic Bearings*. These are found by adding the magnetic variation, if west, or subtracting it if east. For example, if the local magnetic variation is  $10^\circ$  west, and a station is found to bear  $45^\circ$  true, the magnetic bearing of the station will be  $45^\circ + 10^\circ = 55^\circ$ . Fig. 2 will make this clear.

The bearing of  $B$  from  $A$  is  $45^\circ$  true or  $55^\circ$  magnetic.

3. *Magnetic Reciprocal Bearings*. These are found by adding or subtracting  $180^\circ$  to or from the magnetic bearing, and are very commonly used with aircraft, because reversing the bearing is more convenient for the pilot.

Suppose in Fig. 2 that  $A$  is a ground D/F station and  $B$  is an

For stations not on the same meridian, but close together—within, say, 50 miles—the difference between mutual bearings would not be much over one degree. The difference is due to the convergency of the meridians and would be allowed for when necessary by the navigator.

aircraft. *B* presumably wishes to know the compass course which he should follow to reach *A*, i.e. he wants the *magnetic* bearing of *A* from himself. To *A*, this is the reciprocal of *B*'s magnetic bearing from *him*—hence the term Magnetic Reciprocal Bearing.

Having determined *B*'s true bearing as  $45^\circ$ , *A* will then add the magnetic variation plus  $180^\circ$ , giving  $45^\circ + 10^\circ + 180^\circ = 235^\circ$ , which is the magnetic course *B* must follow to reach *A* (neglecting other factors such as drift due to cross-winds).

**Fixes.** The position of a ship or aircraft can be determined by

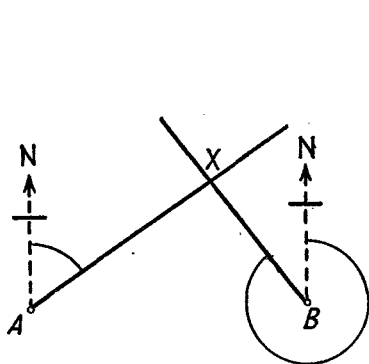

FIG. 3

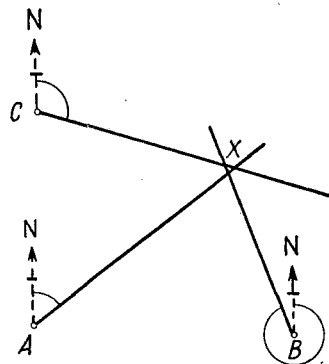

FIG. 4

cross-bearings, and will be the point at which the bearings from two or more D/F stations intersect.

In Fig. 3 *A* and *B* represent two D/F stations. If the bearings of a ship or aircraft are taken and applied to a map, the position of the ship or aircraft must be at *X*. The steps in the process are as follows—

1. Ship (or aircraft) asks D/F station *A* (assumed to be the control station) for position.
2. D/F station *A* asks ship to transmit.
3. D/F stations *A* and *B* take bearing of ship.
4. Station *B* passes bearing to station *A* (by telephone or radio).
5. Station *A* applies both bearings to a map.
6. Station *A* informs ship of result, either in terms of latitude and longitude or by some other agreed method.

Alternatively, the same process can be carried out on the ship using her own D/F apparatus and assuming *A* and *B* to be coast beacons. This, however, means that the time taken will probably amount to several minutes unless *A* and *B* happen to transmit consecutively. While this is of minor importance in the case of a ship, it would be hopelessly inaccurate for an aircraft which has covered, say, 20 miles in 5 minutes. If *A* and *B* are ground D/F stations with expert operators, the fix can be determined and transmitted to the aircraft in little more than a minute.

In modern practice, a 2-bearing fix is not considered sufficiently reliable, and 3-bearing fixes are the rule.

In Fig. 4 a third D/F station *C* has also taken a bearing on the moving station, and the control station *A* applies all three bearings to the map. If the three bearings intersect at a point, this is regarded as a satisfactory fix, and with modern D/F apparatus the three bearings do so intersect in the majority of cases. If a *small* triangle is formed, as in Fig. 4, the fix is given as the centre\* of the triangle, but when the greatest side of the triangle represents more than

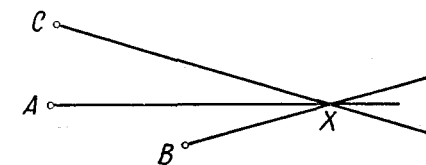

FIG. 5

about 2 miles for each 50 miles of range, either the fixing process is repeated or the position given as "second class."

It should be noted that the accuracy of a D/F fix deteriorates as the angle between the bearings becomes more acute.

In Fig. 5 the position *X* as determined by the cross-bearings from *A*, *B* and *C* is less accurate than position *X* in Fig. 4, even though the three bearings do intersect at a point. This will be explained more fully in Chapter IV.

**Accuracy of D/F Bearings.** As will be seen subsequently, the taking of a bearing by D/F apparatus involves observations of changes in the strength of a very weak signal. With modern equipment and under favourable conditions it is often possible to detect such changes when the moving part of the D/F gear is varied in position by a fraction of a degree, so that the bearing can *apparently* be read to the nearest  $\frac{1}{4}^\circ$  or even less.

It must be remembered, however, that such a performance only reflects credit on the equipment and does *not* mean that bearings can necessarily be regarded as having split-degree accuracy. Many other factors enter into the matter, and "sensitivity" of the direction-finder must not be confused with its accuracy. Fractions of a degree are never used in D/F work, and even if they were true would have no value, because it is not possible to steer a ship or aircraft within such narrow limits. Again, from a practical point of view, a "rough" bearing, too bad to be called even third class, and having a potential error of  $\pm 5^\circ$ , may sometimes be of considerable value to an aircraft which is for the time being lost. The distinction between first-, second-, and third-class bearings will be discussed in Chapter IV.

\* The "centre" means the centre of the *inscribed* circle, i.e. a point equidistant from the sides.

CHAPTER II

ROTATING FRAME D/F

THE first step in the reception of a radio signal is the erection of an aerial system in the path of the wave, thus obtaining a miniature replica of the current in the distant transmitting aerial. The subject of electric wave propagation is a large one, and it is not necessary for the D/F operator to study it academically, but to understand the behaviour of D/F aerials it is essential to have a clear-cut conception of the approaching wave and the manner in which it produces E.M.F.'s in conductors presented to it.

In order to simplify matters, the action will be considered in terms of Faraday's Law, which states that when a conductor is cut by the

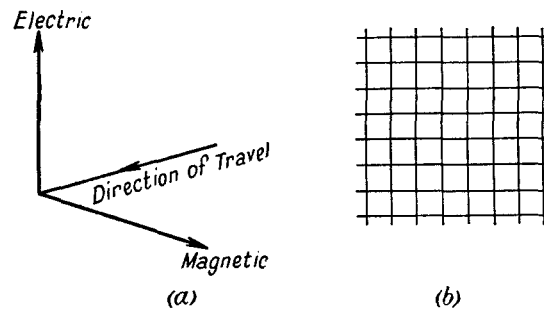

FIG. 6

lines of force of a magnetic field an E.M.F. is induced in the conductor.

An electric wave involves magnetic and electric strains in the carrying medium, i.e. the ether. The lines of electric force, the lines of magnetic force, and the direction of wave-travel are mutually at right angles. Further, both magnetic and electric fields are alternating and are in phase (at distances more than a few wave-lengths from the radiating aerial system). This is often expressed by saying that the magnetic and electric components are in time phase but space quadrature, which means that they reach their corresponding maximum and minimum values together but that the respective lines of force are at 90°.

Fig. 6 (a) shows the relative positions of wave travel and lines of force, and (b) represents the appearance of the wave "front" to an observer facing the transmitter, assuming the lines of force to be visible.

Fig. 7 is a plan view of the transmitting aerial and the circles

represent the radiated magnetic field. If this is visualized as expanding outwards in much the same way as the wave motion on the surface of still water when a stone is dropped into it, a fairly accurate impression is obtained.

A single vertical conductor placed in the path of the wave will clearly be cut by the alternating magnetic field and an E.M.F. will be induced in it. In addition, it is immaterial from what direction

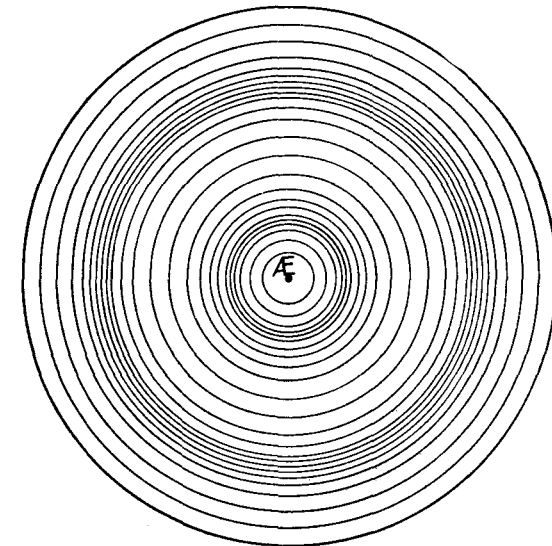

FIG. 7

the wave is arriving, so that for a given field strength, the E.M.F. will be the same for any direction.

**Polar Diagram of Aerial.** A polar diagram is a graph, using polar co-ordinates, which shows the receiving properties of an aerial system for any direction of signal.

With polar co-ordinates the position of a point on the graph is specified by means of an angle and a distance, instead of by two distances as in the case of cartesian co-ordinates.

This method is more convenient for some purposes and should be quite clear from Fig. 8.

In Fig. 8 (a) the point *P* is 3 units from the *x* axis (*OX*) and 4 units from the *y* axis (*OY*).

The distance *OP* is therefore  $\sqrt{3^2 + 4^2} = 5$  and the angle *POX* is  $\tan^{-1} \frac{3}{4} = 37^\circ$  (nearly).

The same point is shown in (b) in which its position relative to *OX* is specified by the distance *r* and the angle  $\theta$  where *r* = 5 units and  $\theta = 37^\circ$ .



To determine the polar diagram of an aerial system experimentally, a portable transmitter would be taken round the aerial at a convenient distance (say 5 miles) and the received signal strength measured for a number of different positions. That is to say, the transmitter would be moved round the circumference of a circle,

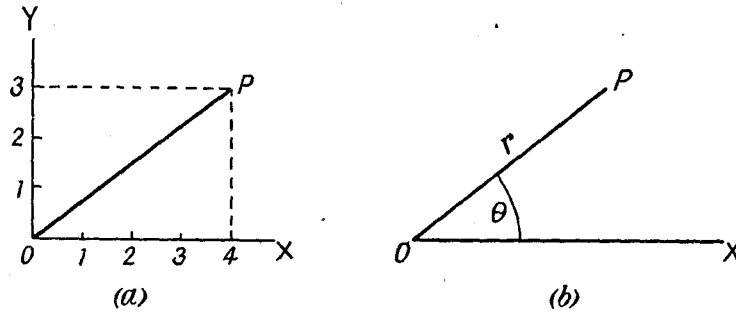

FIG. 8

radius 5 miles and centre the receiving aerial, and the signal strength recorded every few degrees. The strength of signals would not, of course, be judged by ear, but measured on some suitable precision instrument.

The use of polar co-ordinates for construction of the polar diagram will now become clear. Any convenient direction can be taken as the starting line, corresponding to the axis  $OX$  of Fig. 8 (b). The signal strength received from this direction is marked off on a suitable scale, and subsequent points on the graph are specified in terms of angle and signal strength.

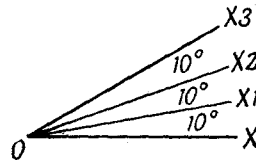

FIG. 9

In Fig. 9 the point  $O$  represents the position of the receiving aerial. The line  $OX$  represents the strength of signals received from a transmitter at a given distance along the line  $OX$  produced.  $OX_1$  represents the strength of signals received from the same transmitter at the same distance along the line  $OX_1$  produced, and similarly for  $OX_2$ ,  $OX_3$ , etc. The points  $X$ ,  $X_1$ ,  $X_2$ ,  $X_3$ , etc., are therefore points on the polar diagram of the aerial, and the complete diagram is formed by joining up all such points. If the strength of signal is found to remain constant for any direction of the transmitter the polar diagram clearly becomes a circle, i.e. the aerial gives "all-round" non-directional reception. This is the case for an ordinary vertical-wire, "T" aerial, "L" aerial, or sausage type, none of these having any noticeable directional properties unless the horizontal portion is several times the length of the vertical portion, which is rarely the case. Even then, the directional property is not very pronounced.

Fig. 10 shows the polar diagrams for the three commonest types of "open" aerial. (a) is the circular diagram for a plain vertical wire or for a "T" or "L" aerial with a fairly short horizontal portion. (b) is the egg-shaped diagram for an "L" aerial, the small cross denoting the lead-in end, and the horizontal portion being about six to ten times the height. It will be seen that the aerial receives best from a direction opposite to that in which the free end is pointing, the radius of the polar diagram being greatest in that direction.

(c) is the elliptical diagram for a "T" aerial with an equally long horizontal portion.

It is important for the D/F operator to become so familiar with the conceptions illustrated by polar diagrams that a mental picture of the diagram concerned accompanies his operation of D/F apparatus.

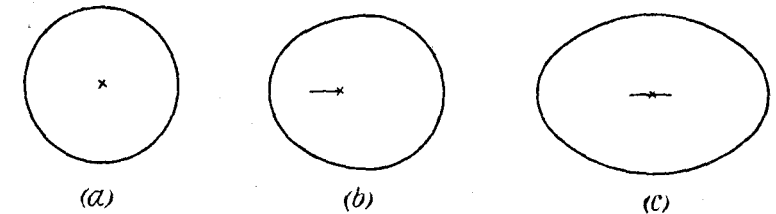

FIG. 10

This is by no means difficult, and it should be remembered that a polar diagram is qualitative rather than quantitative, i.e. it is a handy pictorial way of showing the behaviour of an aerial rather than a mathematical figure. So much is this the case that switches on D/F apparatus are often engraved with small representations of polar diagrams instead of words. The aerial systems and polar diagrams which lead directly to D/F will now be discussed.

**Spaced Open Aerials.** If two ordinary vertical-wire aerials are erected near one another, both will be influenced by a wave arriving from a distant transmitter, and if the two aerials are of the same size and have the same constants (resistance, inductance and capacity) the currents in each will be identical in value. Unless, however, the two aerials are exactly the same distance from the transmitting aerial, the two currents will not be in phase because at any instant the aerials are occupying different positions in the radiated field.

If now both aerials are coupled to the same receiver, signal strength will be found to depend upon (a) aerial spacing, and (b) the position of the line joining the aerials relative to the path of the wave.

These facts are illustrated geometrically in Fig. 11.  $T$  is the distant transmitter,  $A$  and  $B$  represent the positions of two vertical aerials.  $A$  and  $B$  are clearly equidistant from  $T$  when  $AB$  is at  $90^\circ$  to  $TO$ ,  $AB$  then being the base of an isosceles triangle with  $T$  as its

vertex, in which case  $TA = TB$ . Assuming the aerial spacing  $AB$  to remain constant, the greatest phase difference between the currents in the aerials will occur in the position  $A_1 B_1$  when  $A_1$  is nearest the transmitter and  $B_1$  furthest away. For any intermediate

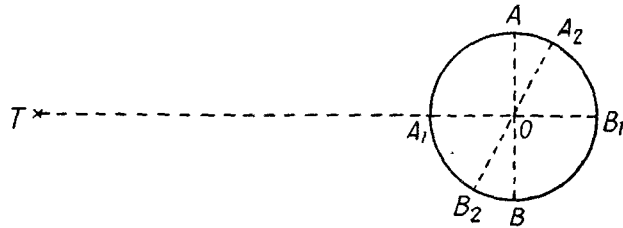

FIG. 11

position such as  $A_2 B_2$  there will be some phase difference, but less than that for position  $A_1 B_1$ .

The extent of the phase difference will depend upon the ratio between aerial spacing and the wave length of the signal.

So far, the aerials have been considered as entirely separate, but for D/F purposes they must be coupled to a common receiver, and

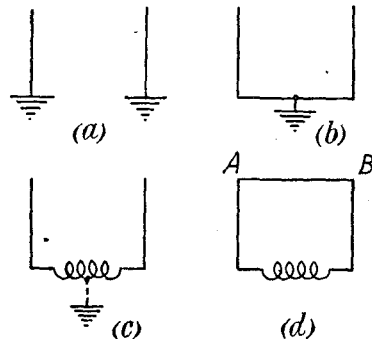

FIG. 12

Fig. 12 shows how a pair of spaced aerials can be developed into a "frame" aerial—

- (a) Spaced open aerials.
- (b) Spaced aerials with common earth lead.
- (c) Spaced aerials with coupling coil. (Centre point may or may not be earthed.)
- (d) Top points connected to form a "frame" or "loop" aerial.

The frame aerial is the basis of all D/F apparatus and depends for its action upon the principles just stated. The polar diagram of a frame aerial can be deduced as follows.

In Fig. 13  $AB$  represents the plan view of a frame aerial, i.e.  $AB$  is the top horizontal member of the frame as shown in Fig. 12 (d).

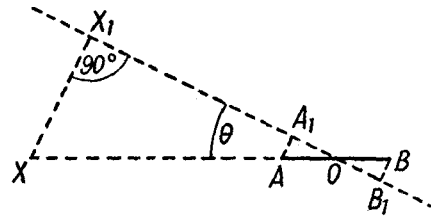

FIG. 13

$O$  is the centre and is the point from which the radii of the polar diagram are measured. Let  $OX$  represent the signal strength from a transmitter in line with the plane of the loop. This will give a maximum phase difference between the E.M.F.'s in the vertical sides of the loop, a maximum resultant loop current, and therefore maximum signal strength.

Now assume that the transmitter is moved round so that the signal is arriving in a direction making an angle  $\theta$  with  $OX$ . The effective frame width is now found by drawing the perpendiculars  $AA_1$  and  $BB_1$ .  $A_1 B_1$  is thus the projection of  $AB$  upon the new signal direction.

It follows that—

$$A_1 B_1 = AB \cos \theta$$

Since the strength of signal is proportional to the effective spacing—

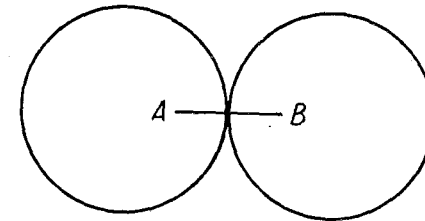

FIG. 14

the radius of the polar diagram in the new direction will be proportional to  $\cos \theta$ , so that—

$$OX_1 = OX \cos \theta$$

and consequently the angle  $OX_1 X$  is  $90^\circ$ . This is true for any direction of signal, and it follows from geometry that the polar diagram will be a circle on  $OX$  as diameter. A similar circle will be formed on the other side, and the complete polar diagram of the frame is shown in Fig. 14.

This is called the figure-8 polar diagram, and its implications will now be discussed.

**D/F with Simple Frame.** In order to use a frame aerial for D/F the frame is rotated about a vertical axis and the position of *minimum* signal strength noted. The plane of the frame will then be at right angles to the direction of the signal and a scale of degrees enables the bearing to be read. The maximum position, when the frame is in line with the signal, is not suitable for D/F, the reason being shown in Fig. 15.

$AB$  is a frame aerial with its associated figure-8 polar diagram.  $OX$  represents the maximum signal strength obtainable and  $OX_1$   $OX_2$  represent the signal strength when the frame is turned  $30^\circ$  on either side of the true maximum position.

Measurement will show that  $\frac{OX_1}{OX}$  is about  $\frac{9}{10}$ , so that the signal strength falls by only about 10 per cent, even when the frame is swung  $30^\circ$ . In addition, there is the fact that the human ear cannot detect small changes in the intensity of a *loud* sound, with the result that it is impossible to determine the maximum position of the frame with any accuracy. Errors of at least  $10^\circ$  would be almost certain, so that the maximum position must be discarded for D/F.

Fig. 16 is an enlarged view of the minimum position. The radius of the polar diagram in the direction  $OY$  at right angles to the frame is, of course, zero, which means that if the frame is in this position relative to the transmitter there will be no signal. An angular

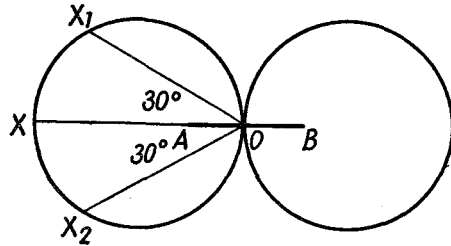

FIG. 15

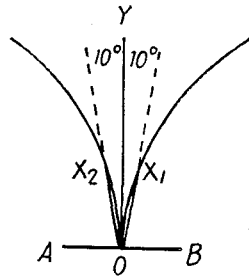

FIG. 16

rotation of the frame through  $10^\circ$  on either side gives a signal strength corresponding to  $OX_1$  or  $OX_2$ . Actually, a  $2^\circ$  swing or less will give an audible signal, but it is not possible to show this on a printed diagram because the lines cover one another. Remembering, however, that  $OX_1 = OX \cos \theta$  (Fig. 15), it can easily be seen how quickly the value of  $OX_1$  changes for small variations of  $\theta$  in the neighbourhood of  $\theta = 90^\circ$ . For instance—

|                   |           |
|-------------------|-----------|
| $\cos 90^\circ$   | $= 0$     |
| $\cos 89.5^\circ$ | $= .0087$ |
| $\cos 89^\circ$   | $= .0175$ |
| $\cos 88^\circ$   | $= .0349$ |

This shows that a rotation of the frame through  $\frac{1}{2}^\circ$  from  $89.5^\circ$  to  $89^\circ$  doubles the signal E.M.F., and a further rotation to  $88^\circ$  doubles it again. From these facts it will be seen that the minimum position is sharply defined and can be located with precision, further assistance being derived from the fact that the human ear is very sensitive to changes in the intensity of a *weak* sound.

**Scales.** The scale on which the bearing is read can be arranged in two ways.

1. Fixed scale and moving pointer.

In this case the scale is engraved clockwise from  $0^\circ$  to  $359^\circ$  with figures every  $10^\circ$ . This arrangement is fairly satisfactory if the

D/F operator is looking down on to the scale when using the apparatus, and can therefore read any part of it, but parallax errors may

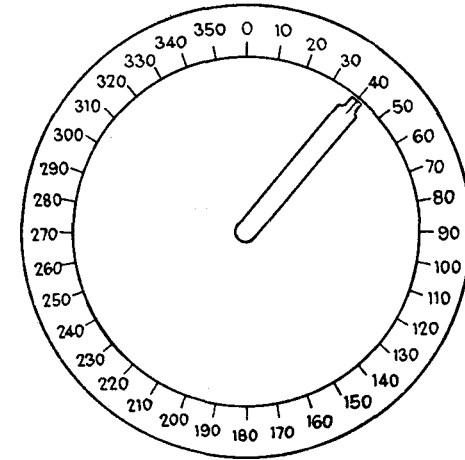

FIG. 17

occur in the neighbourhood of  $90^\circ$  and  $270^\circ$ . In Fig. 17 a bearing of  $40^\circ$  is indicated.

2. Fixed pointer and moving scale.

This is the better scheme and is more usual in rotating loop D/F.

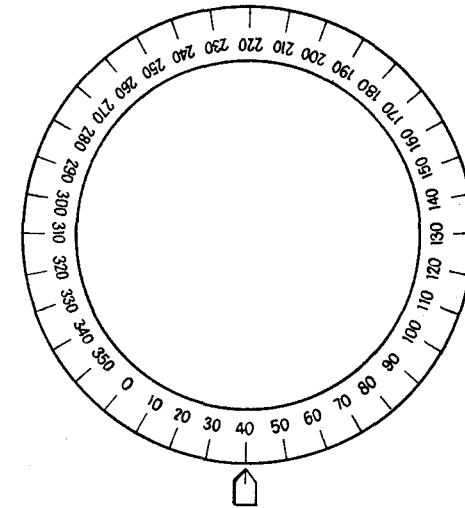

FIG. 18

Since the relative movement is reversed, the scale engraving must be anti-clockwise, as in Fig. 18, in which a bearing of  $40^\circ$  is indicated.

As the pointer does not move, it can be mounted in any convenient position, preferably directly in front of the operator, thus avoiding any parallax error.

NOTE. It will be seen from the symmetry of the figure-8 polar diagram that the minimum position of the frame indicates either the correct bearing or its reciprocal. Thus a scale reading of  $40^\circ$  with a simple rotating loop D/F means that the bearing of the transmitter is either  $40^\circ$  or  $220^\circ$ . The determining of which is correct is called "sensing" the bearing and will be dealt with in a later chapter.

**Setting of Scale or Pointer.** The position of the scale or pointer is quite immaterial, and it is not necessary that the pointer of Fig. 17 should be at  $90^\circ$  to the plane of the loop aerial, or that the pointer of Fig. 18 should have any particular orientation. Only one condition is required for the correct reading of D/F bearings—

*The scale reading must be  $0^\circ$  when the plane of the loop aerial is True East-West.*

Given this condition, the scale and pointer can be arranged in any position found convenient.

**Taking a Bearing.** As will be explained in Chapter V the minimum position of the frame is not always very sharply defined. That is to say, although there is a position which gives a minimum signal, the signal does not fall to zero. In this case, a "swing" bearing is taken, the loop being swung backwards and forwards *through* the minimum position for several degrees on each side of it. Two points of equal signal strength are judged by ear and the bearing taken as half-way between them. This is quite reliable for swings up to about  $7^\circ$ – $10^\circ$  on each side, but if a larger swing is required the bearing must be considered doubtful, even though an experienced operator can judge the apparent minimum position fairly accurately. The term "swing" bearing implies the swinging of the loop in order to locate a minimum which is not zero, but in practice all bearings are taken by swinging the loop. When, however, the minimum is very crisp the extent of the swing will become only about a degree or two, and the loop can be placed "dead on" the minimum instead of estimating the centre point between two equal signal intensities.

**Effect of Frame Dimensions.** Maximum possible strength of signals occurs when the frame diameter is half the wave-length being received.

This is shown in Fig. 19. At any instant, the induced E.M.F.'s in the two vertical limbs will be  $180^\circ$  out of phase. They will therefore act in the same direction in the loop circuit. Any reduction in the diameter of the frame will cause the phase difference to be less than  $180^\circ$  and consequently reduce the resultant E.M.F. It will be obvious that for medium frequencies, such as, for example, the civil aviation D/F wave 333 kcs. (900 metres), the frame diameter is only a small fraction of the wave-length, and the signal strength is proportionately small. A high degree of amplification is, therefore, required in D/F receivers.

An analysis shows that the true cosine polar diagram as in Fig. 14 is obtained only when the frame diameter is about  $\frac{\lambda}{8}$  or less. This is always the case on medium frequencies, but as a matter of interest,

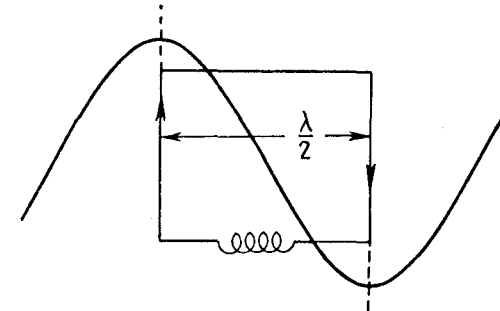

FIG. 19

the polar diagrams for larger frames are shown in Fig. 20, from which it will be seen that the frame will follow the cosine law for diameters almost up to  $\frac{\lambda}{4}$  at which the flattening of the circles is very slight.

On short-wave D/F, however, the question of aerial spacing assumes some importance and will be referred to again in a later chapter.

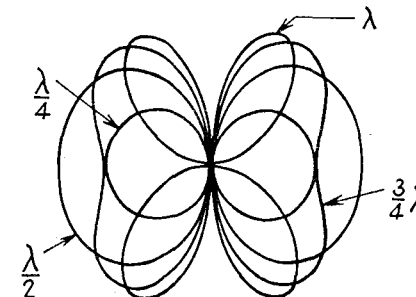

FIG. 20

**Rotating Beacon D/F.** This is an application of directional transmission for D/F purposes. The polar diagram of a frame aerial is reversible, i.e. it also represents the distribution of radiated energy if the aerial is coupled to a transmitter. If such a frame is slowly rotated at a known speed and is keyed automatically to send identification signals at known positions, distant receiving stations (i.e. ships or aircraft) can take bearings on the transmitter with no apparatus other than an ordinary receiver and a stop-watch.

The transmitting frame is rotated mechanically at a uniform speed of 1 revolution per minute and two positions of the frame are indicated on each revolution, one when the plane of the frame is

east-west and another 15 seconds later when the plane of the frame is north-south. The two positions are identified by means of morse letters, different pairs of letters being used for different beacons. Each transmission occupies 4 minutes, and the beacon is then silent whilst other beacons are operating, transmissions taking place in turn.

The method of using the beacon will be best understood from Fig. 21, which shows the details of transmission.

An important point to remember, and one which is frequently

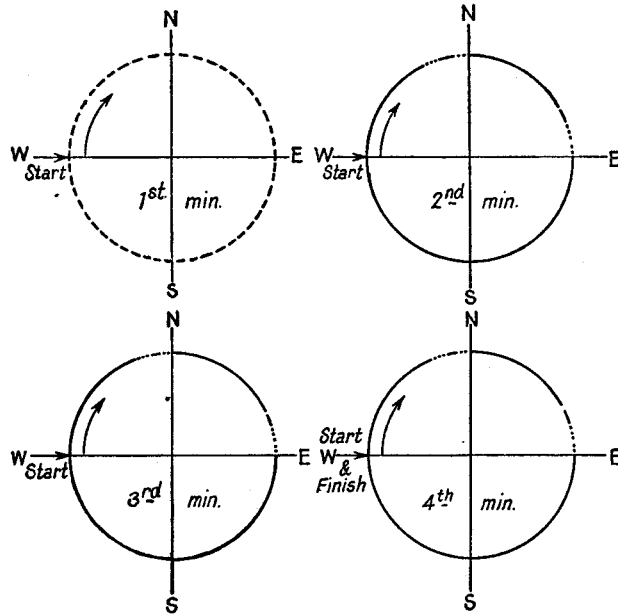

FIG. 21

misunderstood, is that the position of the frame at the *north* starting signal is *east-west*. An aircraft or ship which is nearly due north or south of the beacon will, therefore, not hear this signal because the frame will, at that moment, be at  $90^\circ$  to his bearing. This is the reason for providing the *east* starting signal which occurs when the frame is *north-south*.

To take a bearing on the beacon the stop-watch is started at the commencement of the long dash, either at north or east. To facilitate accurate starting of the stop-watch, the two executive dots are provided immediately following the identification letter. These are equally spaced from each other and from the start of the long dash, so that by counting 1—2—3 the watch can be started with precision. The signal must clearly pass through a minimum and the watch is stopped at the instant of minimum signal strength. The frame is

rotating at  $6^\circ$  per second, so that the bearing is given by a simple calculation from the stop-watch reading.

Fig. 22 (a) shows the result of using the north starting signal.  $AB$  represents the position of the frame at the instant of starting

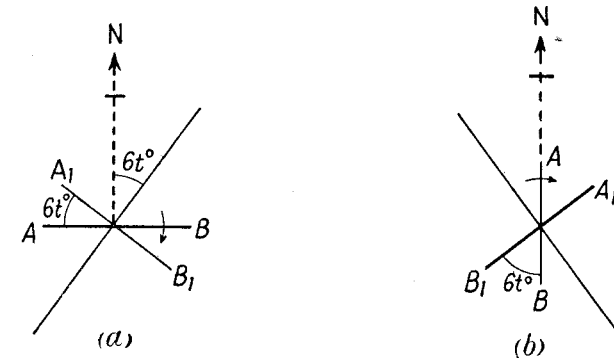

FIG. 22

the stop-watch. If  $A_1B_1$  is the position of the frame at the minimum signal the bearing of the receiving station must clearly be on the line at right angles to  $A_1B_1$ . If  $t$  seconds are shown on the stop-watch, the bearing will be either  $6t^\circ$  or  $(6t + 180)^\circ$ .

In Fig. 22 (b) the east starting signal has been used.  $AB$  represents

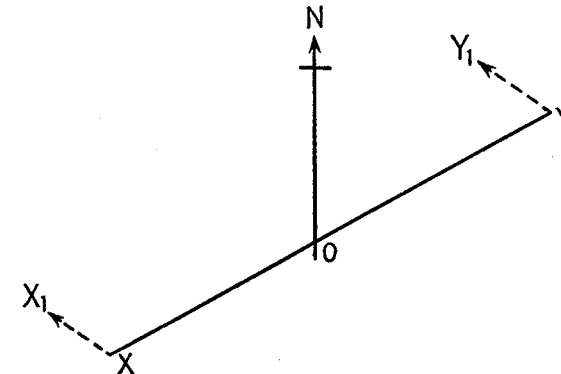

FIG. 23

the position of the frame at the instant of starting the stop-watch, and  $A_1B_1$  the position of the frame at the minimum. The bearing will be the line drawn at right angles to  $A_1B_1$  and will either be  $(6t + 90)^\circ$  or  $(6t + 270)^\circ$ .

The bearings obtained can be accurate to about  $\pm 2^\circ$  after a little practice. The tendency at first is to wait too long for the minimum which has to be more or less anticipated in order to stop

the watch at the right moment. The bearings are of course unsensed, but this is not of great consequence in most cases, the correct bearing being known from other facts. Should there be any doubt, the change in the bearing on a later observation will remove it.

In Fig. 23,  $O$  represents the beacon site. Suppose an aircraft takes a bearing on the beacon and gets the line  $XY$ , but is not sure whether the correct bearing is  $OX$  or  $OY$ . The course of the aircraft will naturally be known. Assuming this to be about north-west, the track of the aircraft is represented by the line  $XX_1$  or  $YY_1$ . It will be clear from an inspection of Fig. 23 that the subsequent bearing will be numerically *less* if the aircraft is on  $YY_1$  and numerically *greater* if the aircraft is on  $XX_1$ . The sense of the bearing can then be deduced. In any particular case, a rough diagram or a mental picture will show the interpretation of an increasing or decreasing bearing.

## CHAPTER III

### BELLINI-TOSI D/F

It has been mentioned that a very high degree of amplification is required with rotating loop D/F because of the smallness of the loop diameter compared with wave-length. High amplification inevitably results in an increase in the general noise level of the receiver with a consequent tendency to mask the minimum position of the frame, and large frame aeriels become unwieldy, making the D/F process slower and more laborious. About 1907, the research workers Bellini and Tosi developed a D/F system using fixed frames, and this system is now practically standardized for permanent ground D/F stations. It is referred to as the Bellini-Tosi, or more simply, the B.T. system. Its two great advantages are—

1. As the frame aeriels are fixed, they can be made very much larger than a rotating loop.
2. The D/F process is carried out by swinging a small light "search" coil, and is therefore very rapid.

A B.T. aerial system consists of two fixed loops at  $90^\circ$  to each other. The orientation of the loops is not important, but it is usual to mount them so that the plane of one lies true north-south and that of the other true east-west. As will be shown later, this assists in calibration of a new station. When B.T. aeriels are used on a ship or aircraft, they are mounted so that the plane of one of them lies in the fore-and-aft line, the other one therefore being athwartships.

**The Radiogoniometer.** This instrument, in conjunction with B.T. aeriels, constitutes the complete B.T. D/F system.

The general principle of the goniometer is shown in Fig. 24. The two fixed coils  $A$  and  $B$  are called the stator coils and are at  $90^\circ$  to each other. Each stator coil forms part of one frame circuit. Mounted centrally in the space between the stator coils is a small coil called the search coil, which is connected to the receiver. Connections to the search coil are made by means of slip-rings so that it can be freely rotated without encountering stops. A scale and pointer associated with the search coil spindle completes the arrangement.

The search coil is in effect a small frame aerial and has a figure-8 polar diagram, by virtue of which D/F is carried out. Electrically, however, the method is equivalent to the rotation of a much larger frame, comparable in size to the actual B.T. aeriels.

The action of the goniometer can be analysed as follows.

Fig. 25 represents the stator coils of the goniometer. (For reasons shortly to be discussed, each stator coil is always wound in two sections.)

Consider the case of a given transmitter at a given distance from the D/F station. If this transmitter is due north or south, i.e. in line with the N.-S. loop, there will be no resultant current in the E.-W. loop, and a maximum current in the N.-S. loop. Similarly,

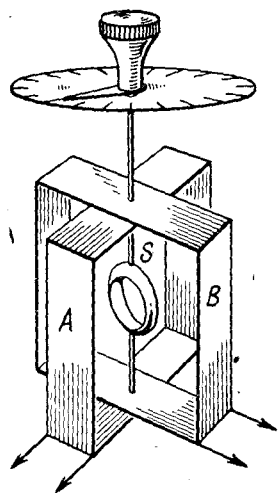

FIG. 24

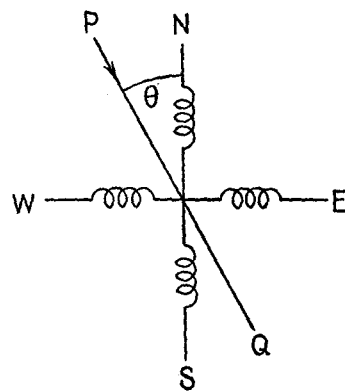

FIG. 25

if the transmitter is due east or west, there will be maximum current in the E.-W. loop and none in the N.-S. loop.

Let  $I_1$  = current in N.-S. loop for a transmitter due N. or S.  
Let  $I_2$  = current in E.-W. loop for the same transmitter at the same distance due E. or W.

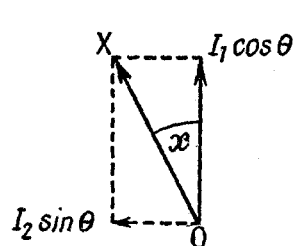

FIG. 26

Now consider the case for an intermediate direction making an angle  $\theta$  with the N.-S. loop, and assuming the same transmitter at the same distance (the line  $PQ$  in Fig. 25).

$$\begin{aligned} \text{Current in N.-S. loop} &= I_1 \cos \theta \\ \text{Current in E.-W. loop} &= I_2 \cos (90^\circ - \theta) \\ &= I_2 \sin \theta \end{aligned}$$

Inside the goniometer there will thus be two fields at  $90^\circ$  to one another, the field intensities being represented by  $I_1 \cos \theta$  and  $I_2 \sin \theta$ . The direction of the resultant field can be found from the parallelogram law. This is done in Fig. 26.

The line  $OX$  represents the resultant field in magnitude and direction.

Examining the diagram, it will be seen that

$$\begin{aligned} \tan x &= \frac{I_2 \sin \theta}{I_1 \cos \theta} \\ &= \frac{I_2}{I_1} \times \tan \theta \end{aligned}$$

If therefore  $\frac{I_2}{I_1} = 1$ , we shall have

$$\begin{aligned} \tan x &= \tan \theta \\ x &= \theta \end{aligned}$$

That is to say, the resultant field in the goniometer is in exactly the same position relative to the stator coils as the outside signal is relative to the B.T. frames. By rotating the search coil to give a minimum, the direction of the resultant field and hence of the distant transmitter can be determined.

The condition  $\frac{I_2}{I_1} = 1$  implies, of course, that  $I_1 = I_2$ , which means absolutely equal receptive properties in each B.T. loop. The two frame aerials must, therefore, be accurately matched and possess the same resistance, inductance, and capacity. The success of the B.T. system depends upon this matching.

NOTE. The maximum strength of signals is independent of direction and is always equal to the strength of signals which would be received on one loop alone. The value of  $OX$  in Fig. 26 is

$$\begin{aligned} &\sqrt{(I_1 \cos \theta)^2 + (I_2 \sin \theta)^2} \\ &= I_1 \sqrt{\cos^2 \theta + \sin^2 \theta} \\ &= I_1 \text{ (or } I_2) \end{aligned}$$

**Matching of B.T. Aerials.** It is a comparatively simple matter to secure correct physical matching of B.T. loops, and proper care in mechanical details will produce two loops which have identical electrical constants. Unfortunately the problem by no means ends here. A frame aerial is an oscillatory circuit and, therefore, works most efficiently when tuned to resonance with the frequency of the wanted signal. If both B.T. loops could be tuned accurately to resonance all would be well, but it is extremely difficult to do this. The exact resonant point is never very sharply defined in an aerial circuit, and in low resistance oscillatory circuits a small amount of mistuning will produce quite large phase angles between E.M.F. and current. This can be seen from the expression

$$\tan \theta = \frac{\text{Reactance}}{\text{Resistance}}$$

where  $\theta$  is the phase angle.

If resistance is small, the accuracy of tuning required to make  $\tan \theta = 0$  is far in excess of that realizable in practice. Different phase angles in the two aerials will cause a rotating magnetic field in the goniometer and the search coil minimum will become flat, or in bad cases indistinguishable. From these facts it can be seen that whilst it is not essential that the B.T. frames shall be resonant to the particular frequency being received, it is essential that they should both be resonant to the same frequency—in other words that the amount of mistuning is the same in each case.

In modern B.T. equipment, no attempt is made to tune the aerials, which are, therefore, called aperiodic loops. The disadvantage of this scheme is that aerial current is reduced, and in order to increase the pick-up the search coil has to be more tightly coupled

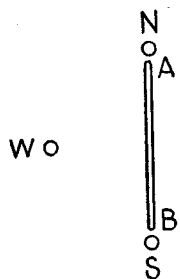

FIG. 27

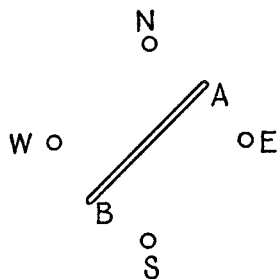

FIG. 28

to the goniometer stator coils, i.e. its diameter is made as large as can be accommodated inside the goniometer. This tight coupling leads to a special kind of error.

**Goniometer Coupling Error (Octantal Error).** In order to understand how coupling error arises, it is easiest to consider an extreme case in which each stator coil has one turn only and the search coil also has one turn.

In Fig. 27 a sectional plan view of the stator coils is shown and AB represents the search coil in the position it would occupy when taking a bearing on a station due east or west. No error arises in this case because only the east-west stator coil contributes to the field. The same applies to the case where a signal is coming from true N. or S.

Fig. 28 shows the position of the search coil when taking a bearing on a signal arriving from 135° or 315°. Again no error arises because the search coil is symmetrically disposed with reference to the stator coils and each stator coil is contributing equally to the resultant field. The same applies to the case where a signal is coming from 45° or 225°.

In Fig. 29 the signal is taken as coming from 112½° or 292½°. To obtain a correct bearing the minimum should occur when the search coil is in the position AB, 22½° from the N.-S. stator coil.

This, however, will not be the case because the search coil is closer to the N.-S. stator coil than to the E.-W. coil. A magnetic field surrounding a conductor carrying a current is not uniform, but decreases rapidly with increasing distance from the conductor. As the search coil is closer to the N.-S. stator coil, it is in a relatively more intense part of the N.-S. field, with the result that the effect of the N.-S. coil is exaggerated and a signal will still occur. To obtain a minimum, the search coil will have to be rotated away from the N.-S. stator coil through a small angle to a position such as CD in Fig. 29. The angle between AB and CD constitutes the coupling error, which is greatest at the eight octantal points 22½°, 67½°, 112½°, etc. Fig. 30 shows a graph of a typical coupling error.

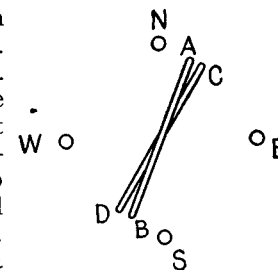

FIG. 29

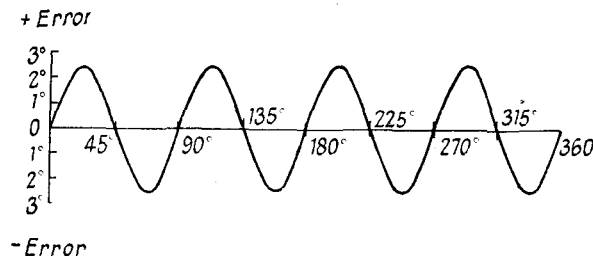

FIG. 30

The methods of reducing coupling error consist of—  
(a) Spreading out the stator coil windings so that the magnetic field becomes more uniform.

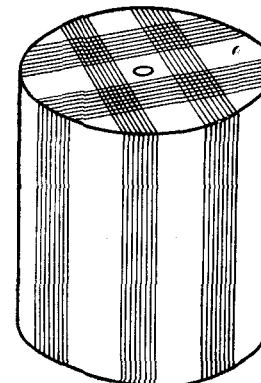

FIG. 31

Fig. 31 shows how this is done in an actual goniometer.

(b) special designs of search coil windings to reduce the effect of the unbalanced fields.

By these means, the residual coupling error can be reduced to negligible proportions.

**Goniometer Scales.** A radiogoniometer always has a fixed scale and moving pointer, the pointer being attached to the search coil spindle. The scale reading must, of course, be 0° when the plane of the search coil is in line with the E.-W. stator coil. The position of the goniometer in the D/F cabin is not important



and can be decided with regard to convenience only. Sometimes the goniometer is built into the D/F receiver, but it is often a separate instrument, in which case it can be placed anywhere on the bench. The position usually considered best is on the left of the operator and turned so that he faces it squarely. The size of the scale varies quite considerably, but a large scale is better than a small one. With a 6-inch diameter scale each degree occupies about .05 inch, which is easily read. Larger scales than this are often used. The search coil spindle must be exactly concentric with the scale or an error will occur, due to 180° of search coil rotation not corresponding with 180° on the scale. It will be seen, therefore, that a radiogoniometer calls for precision engineering, and, although a simple instrument, should always be treated with care.

## CHAPTER IV

### SENSING AND FIXING

It has been shown that the bearings taken by rotating loop or goniometer D/F are subject to a 180° uncertainty owing to the symmetry of the figure-8 polar diagram. If, for example, a minimum is obtained at 15° on the scale, another minimum will also occur at 195° and the bearing of the distant transmitter may be either.

Although the correct bearing would be obvious in many cases, the 180° doubt is not desirable in practical D/F, nor would it be possible for a D/F station to give magnetic reciprocal bearings when requested. The process of determining which of the two figure-8 minima is the correct bearing is called sense-finding or sensing the

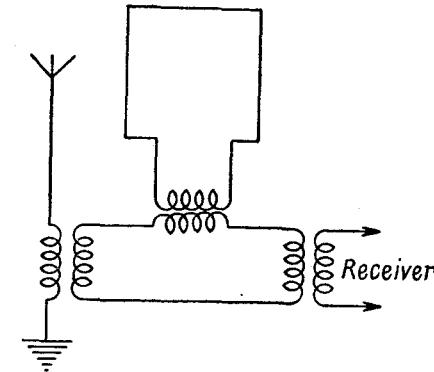

FIG. 32

bearing, and all modern D/F stations give sensed bearings to the ships or aircraft which call.

Since the 180° doubt arises simply through the symmetry of the figure-8 polar diagram, it is clear that sense could be determined if a non-symmetrical polar diagram were available; that is to say, a diagram having one minimum and one maximum only, instead of two equally spaced maxima and minima. Such a polar diagram can be obtained by combining a frame aerial and an open vertical-wire aerial coupled to the same receiver.

Fig. 32 shows the basic sense-finding circuit. Since both aeri- als are supplying a signal to the receiver, it will be clear that the polar diagram of the combination will be different from both the circle diagram of the open aerial and the figure-8 diagram of the loop. The effect can be easily seen if the loop is assumed to be in its maximum position with regard to some distant transmitter.

This is shown in Fig. 33 (a) in which the arrows represent the directions of the E.M.F.'s at some particular instant. If now the loop is turned through 180°—Fig. 33 (b)—the resultant E.M.F. for the same instant will be reversed in the loop circuit. The two

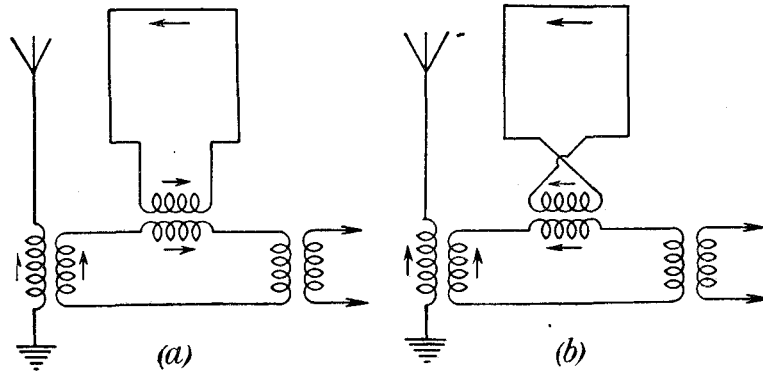

FIG. 33

E.M.F.'s due to the open aerial and the loop will thus be aiding one another for one position of the loop and in opposition for the other. The combination will, therefore, give one maximum and one minimum position instead of two equal maxima as in the case of the

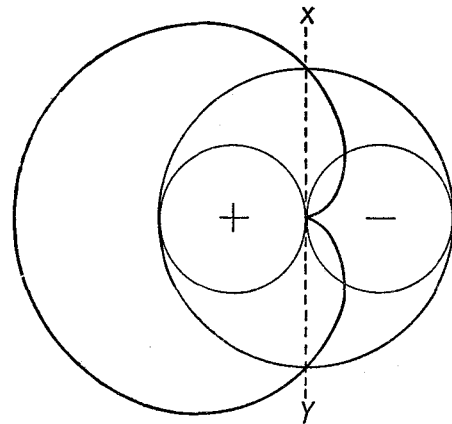

FIG. 34

frame alone. The reversal of E.M.F. in the frame occurs as it passes through the minimum position, so that the frame E.M.F. must be considered positive for one circle of the figure 8 and negative for the other, the open aerial E.M.F., of course, remaining positive, as this is unaffected by direction.

The new polar diagram is constructed as shown in Fig. 34 in which the receptive properties of the two aerials are taken as equal, i.e.

the signal E.M.F. due to the open aerial is the same as that due to the frame when the frame is in the maximum position.

The radii of the circle and figure-8 polar diagrams are added on the left of the minimum line XY and subtracted on the right. The new polar diagram shown by the heavy line is called the cardioid or, more usually, the heart-shape polar diagram.

If the receptivity of the two aerials is not the same, the heart-shape diagram will be distorted.

Fig. 35 (A) shows the result when the frame contributes a greater signal than the open aerial, and is often called a "cottage loaf" diagram.

Fig. 35 (B) shows the effect of too much vertical aerial reception. The heart-shape minimum becomes rather flat.

Neither case, however, prevents sense determination because the

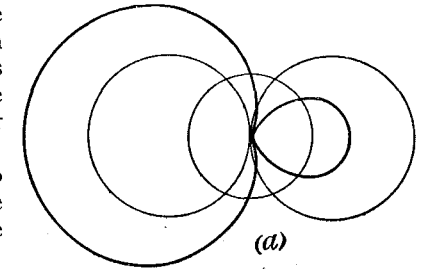

FIG. 35A

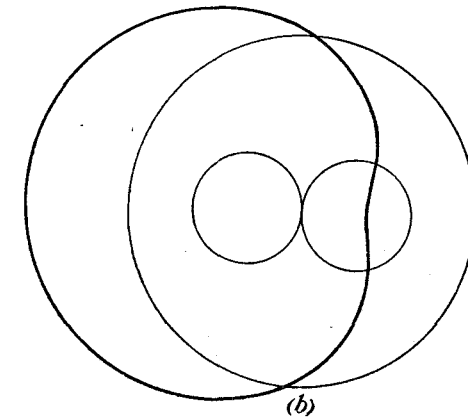

FIG. 35B

only requirement is sufficient difference between the heart-shape minimum and maximum. The "perfect" heart-shape of Fig. 34 is not always easy to obtain and in practice is not invariably aimed at. So long as a reasonable approximation to heart-shape reception is available, bearings can be satisfactorily sensed.

Two points regarding the heart-shape diagram should be noted.

1. The heart-shape maximum is much greater than the figure-8 maximum.

2. The heart-shape maximum or minimum is at 90° to the figure-8 minimum.

**Phasing for Sense-finding.** In the circuit of Fig. 33 and in constructing the diagrams of Figs. 34 and 35, it has been assumed that the voltages induced in the intermediate circuit by the open aerial and the frame aerial are either in phase or anti-phased, and unless

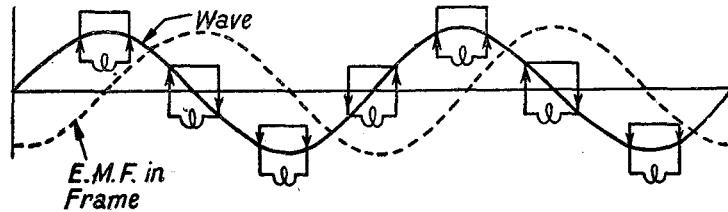

FIG. 36

this is the case the reasoning breaks down and heart-shape reception does not exist. Unfortunately, a 90° phase difference occurs to start with, because the E.M.F. induced in an open aerial is in phase with the wave influencing it, whereas the resultant E.M.F. in a frame aerial lags 90° on the wave. This is shown in Fig. 36.

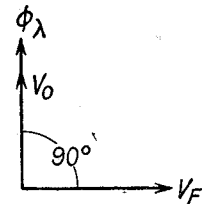

FIG. 37

Since the E.M.F.'s induced in the intermediate circuit depend upon the currents flowing in the two aerials, the problem resolves itself into the conversion of two E.M.F.'s which are necessarily and permanently 90° out of phase into two currents which are in phase or anti-phased according to the position of the frame aerial.

This is shown vectorially in Fig. 37, in which  $\phi_\lambda$  represents the magnetic component of the wave,  $V_o$  the E.M.F. in the open aerial, and  $V_F$  the resultant E.M.F. in the frame.

The required phase relationship between aerial currents can be secured in various ways, of which two will be described.

1. BY TUNED AERIALS

This method is not now employed, but it serves to illustrate the problem. If the open aerial is tuned to a frequency higher than that being received, it will have capacity reactance and current will lead on E.M.F. If the frame is tuned to a frequency lower than that being received it will have inductive reactance and current will lag on E.M.F. By appropriate tuning—or rather mistuning—of the aerials it is, therefore, possible to secure in-phase or anti-phase conditions.

Fig. 38 (a) shows how the anti-phase condition would occur with a 30° leading phase angle in the open aerial circuit and a 60° angle of lag in the frame circuit. This represents the heart-shape minimum.

If now the frame is turned through 180°,  $V_F$  is reversed in the frame circuit and the situation is as shown in Fig. 38 (b), which represents the heart-shape maximum.

Whilst theoretically very promising, this method is troublesome in practice and for reasons which need not be discussed here there is some risk of sense reversals.

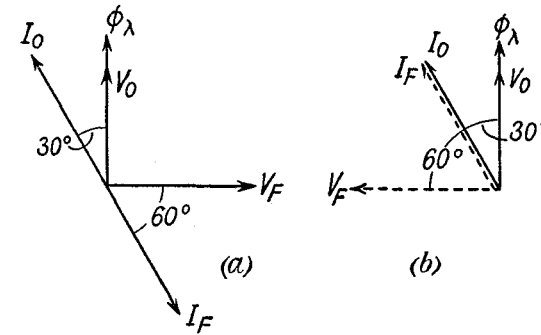

FIG. 38

2. APERIODIC OPEN AERIAL AND UNTUNED FRAME

If an oscillatory circuit has a high resistance, current and E.M.F. will be nearly in phase over quite a large range of frequency because

$$\tan \theta = \frac{\text{Reactance}}{\text{Resistance}} \quad (\theta \text{ is the phase angle})$$

and, if resistance is large,  $\tan \theta$  will remain small even for considerable values of reactance. The insertion of a high resistance in the open aerial will, therefore, stabilize the phase angle to a small value.

If the frame aerial is not tuned, it becomes almost entirely inductive. (Frame aerials have sometimes been called inductance aerials

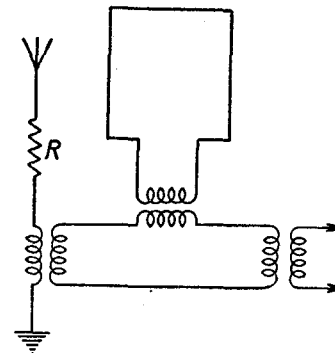

FIG. 39

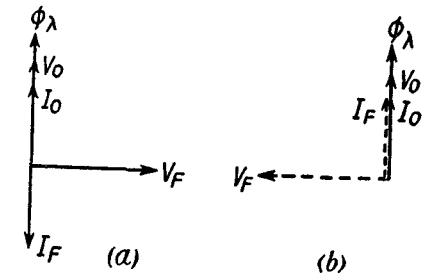

FIG. 40

as distinct from the capacity aerial formed by the ordinary suspended wire.)

The circuit is now as shown in Fig. 39.  $R$  is called the phasing resistance and will have a value from 1000 to several thousand ohms.

Fig. 40 shows the situation vectorially. (a) represents the heart-shape minimum, and (b) the result of turning the frame through  $180^\circ$ , thus giving the heart-shape maximum.

The phase angles will not, of course, be exactly  $90^\circ$  as shown in Fig. 40, and the heart-shape minimum will not always be very sharp. This, however, does not matter so long as there is a pronounced difference between the heart-shape maximum and minimum.

Other circuit arrangements for heart-shape are used, and examples are shown in Figs. 75 and 76, but in all cases the final result is the same, i.e. in-phase or anti-phased E.M.F.'s to the first amplifying valve.

**Valve-coupled Open Aerial.** Fig. 41 shows a scheme employed on some D/F stations to obtain an almost completely aperiodic open

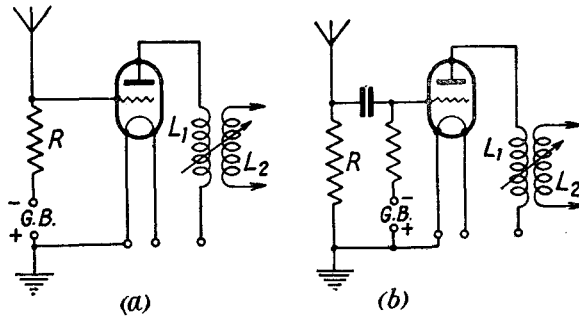

FIG. 41

aerial. The resistance  $R$  is about 100,000 ohms and the valve is biased to zero grid current and works on a straight portion of its mutual characteristic. The variable coupling between  $L_1$  and  $L_2$  serves to control the amplitude of the signal from the vertical aerial and is useful to secure a heart-shape balance.

Fig. 41 (b) is a rather better arrangement than (a) because sudden static charges on the open aerial due to atmospherics do not affect the valve so much.

**The Complete Process of D/F.** The foregoing should now enable the reader to follow the complete process of taking sensed bearings on a D/F station.

**Stand-by Position.** A permanent D/F station exists to give D/F service to ships or aircraft which may call. For D/F watchkeeping, therefore, the aerials must be non-directional and have a circle polar diagram so that any ship or aircraft calling will be heard. This is called the "stand-by" position and is provided by the vertical

aerial. The vertical aerial (often termed the sense aerial) thus serves the double purpose of giving all-round reception for watch-keeping and heart-shape reception when used in conjunction with the frame or search coil.

**D/F Position.** For D/F, the vertical aerial is cut out and reception is effected on the frame or search coil alone, thus using figure-8 reception.

**Sense Position.** For sensing the bearing, the vertical aerial is switched in again and a heart-shape polar diagram obtained.

Every D/F apparatus has a three-position switch marked "Stand-by," "D/F," and "Sense." In some cases the positions of the switch are not marked in words but by small polar diagrams engraved on the plate (Fig. 42).

**Taking Bearings with Goniometer.** A complete goniometer has three pointers—

1. The D/F pointer which is fixed at  $90^\circ$  to the plane of the search coil and indicates one of the two figure-8 minima.

2. The magnetic reciprocal pointer which is fixed  $180^\circ$  from the D/F pointer, plus or minus the local magnetic variation—plus for a westerly variation and minus for an easterly one.

3. The sense pointer, fixed at  $90^\circ$  to the D/F pointer and indicating the heart-shape minimum (see Fig. 34). This is made shorter than the other two because scale readings are not required when sensing a bearing and a sense pointer of the same length as the D/F pointer might cause confusion.

Fig. 43 shows the appearance of a goniometer, the magnetic reciprocal pointer being set for a local magnetic variation of  $11^\circ$  West.

The three steps of D/F in modern practice are as follows—

#### 1. ROUGH LOCATION OF THE MINIMUM

As soon as the ship or aircraft calls and requests a bearing, the D/F station replies by the appropriate signal meaning "Please send your call-sign and long dashes so that I can take your bearing." The "stand-by" switch is then changed to "D/F" giving figure-8 reception and the position of the minimum found approximately by a rapid swing of the search coil.

#### 2. DETERMINATION OF SENSE

The switch is turned to "sense," and the search coil rotated until the sense pointer occupies the minimum position just found. The sense pointer is then swung through  $180^\circ$  and the strength of signals compared in the two positions. This locates the minimum of the heart-shape diagram and hence the sense of the bearing.

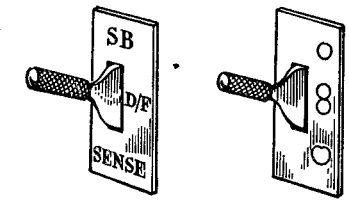

FIG. 42

### 3. ACCURATE DETERMINATION OF BEARING

The switch is now returned to "D/F," the D/F pointer swung to the heart-shape minimum just ascertained and an accurate determination of the figure-8 minimum is made.

An experienced operator can complete these three steps under favourable conditions in about 10 seconds or even less, and practice

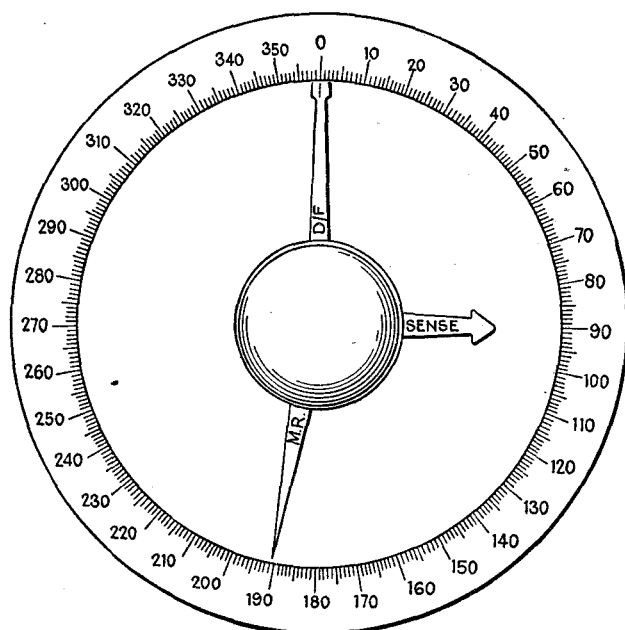

FIG. 43

in simultaneous manipulation of the search coil and "D/F-sense" switch gives considerable skill in interpreting what is heard.

**Sense Amplitude Control.** In order to provide good signal strength on the "stand-by" position, the open aerial is often rather larger than that required for a heart-shape balance. (A heart-shape balance means equality of signal strength on the open aerial and the frame maximum, phasing assumed correct, thus giving the true heart-shape of Fig. 34 with a sharp sense minimum.)

Although a rough heart-shape such as Fig. 35 is good enough for sensing a bearing, it is more pleasant and permits faster working to have a true heart-shape, and as a D/F station keeps watch on one frequency only for indefinite periods it is worth while providing adjustments by which a really good heart-shape can be obtained for any particular frequency covered by the apparatus.

The phasing arrangements for cardioid reception are usually fairly rigid and do not allow of much, if any, adjustment, but it is

of course a simple matter to control the input from the open aerial by varying the coupling. This is shown in Fig. 41 in which there is variable coupling between the coils  $L_1$  and  $L_2$  and the control knob would be marked "Open Aerial Coupling" or "Sense Amplitude." The heart-shape balance is secured by setting the goniometer on a known heart-shape minimum and adjusting the coupling to give minimum signal strength. This point can then be marked in pencil as the best sense position and the control set to it when sensing a bearing. For the "stand-by" position it may be found desirable to increase the coupling to maximum.

**First-, Second-, and Third-class Bearings.** Due to various causes which will be discussed in the following chapter, the figure-8 minimum is not always sharp and the sharpness will vary from time to time on the same D/F station.

It has been explained that all bearings are taken by swinging the frame or search coil, the extent of the swing necessarily increasing as the minimum becomes less well-defined. Bearings are classified in terms of the swing necessary to locate the minimum and the following figures represent general practice.

First class. Minimum clearly shown on a  $4^\circ$  swing ( $2^\circ$  on each side).

Second class. Minimum shown by a swing between  $5^\circ$  and  $10^\circ$  (from  $2\frac{1}{2}^\circ$  to  $5^\circ$  on each side).

Third class. Minimum located by a swing exceeding  $10^\circ$  (more than  $5^\circ$  on each side).

If the frame or search coil has to swing more than about  $20^\circ$  to find the minimum, the bearing would be regarded as doubtful or perhaps not given. A bearing which is within the swing limits for second class is nevertheless given as third class if the minimum is "woolly." This is rather a difficult term to explain in words, but a new D/F operator will very soon realize what it means—a general vagueness of the minimum is perhaps the best phrase.

**Fixing Service.** It was shown in Chapter I that the position of a ship or aircraft can be determined by means of simultaneous bearings taken by two or more D/F stations. The fact, however, that no D/F bearing is absolutely accurate in the strict geometrical sense results in the necessity for caution in giving positions, especially at long ranges.

Fig. 44 shows two D/F stations, *A* and *B*, fixing a ship or aircraft *X*. A first-class bearing can usually be taken as accurate within  $\pm 1^\circ$ , so that the bearings should be represented not by a single line, but by two lines making an angle of  $2^\circ$ . The position of the ship or

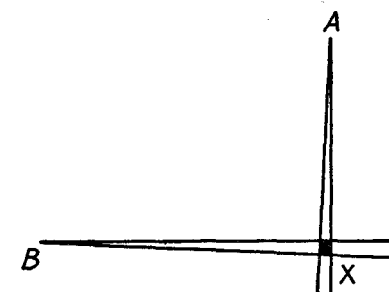

FIG. 44

aircraft is, therefore, not defined by a point but by the small shaded quadrilateral. The area in square miles represented by this quadrilateral increases (a) with distance, and (b) as the angle between the bearings becomes more acute. (Fig. 45.)

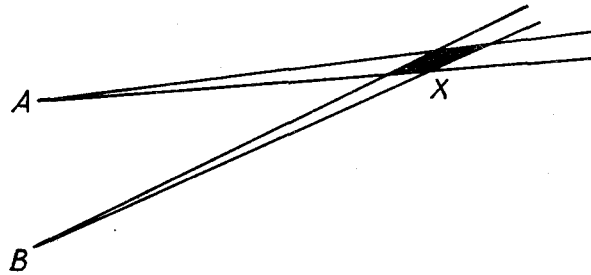

FIG. 45

The addition of a third bearing from another D/F station increases the accuracy of the fix by reducing the "area of doubt."

Fig. 46 is the same as Fig. 45, with a third station C also taking a bearing. It will be seen that the area of doubt is now much smaller.

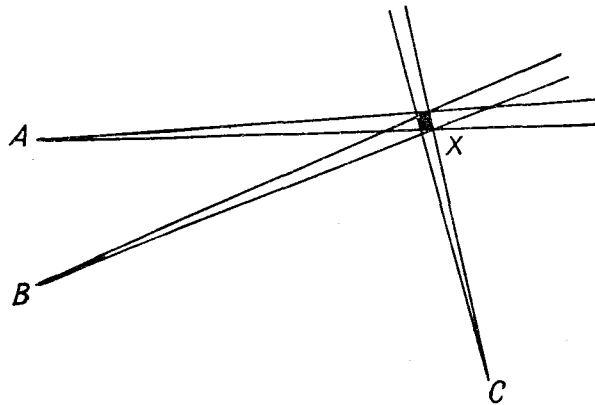

FIG. 46

Calculations of the area of doubt for various distances give some impressive results. Using three D/F stations, and assuming first-class bearings with a possible error of  $\pm 1^\circ$ , the area of doubt is 12 square miles at 100 miles range, which is small and certainly accurate enough for an aircraft which will have left the area of doubt almost before the position is passed to him. At 500 miles, however, the area of doubt becomes 300 square miles, which is unpleasantly large. With a possible D/F error of  $\pm 5^\circ$  the area of doubt is 300 square miles at 100 miles range, whilst at 500 miles range it becomes 7600 square miles, thus reducing position finding

to an absurdity. This does not mean that radio fixing is ineffective or unreliable, but it does emphasize the necessity for three D/F stations, first-class bearings, and care in interpreting the results.

**Fixing by a Single D/F Station.** The following method of obtaining an approximate fix by one D/F station is sometimes used for aircraft. The D/F station is assumed to be at the airport of destination so that the aircraft is flying towards the D/F station on a magnetic reciprocal course.

In Fig. 47, *O* represents the D/F station and the line *XO* the track of the aircraft. At a pre-arranged moment the aircraft's course is changed  $45^\circ$  to *AB*, and this course is held until the aircraft is at a known distance, say 3 miles, from its original track. The aircraft

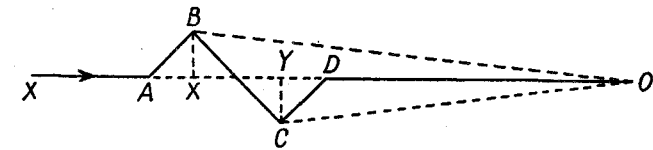

FIG. 47

then calls the D/F station and a bearing is taken. Course is then changed  $90^\circ$  (*BC*) until the same distance on the other side of the original course is reached, and another bearing is taken. The aircraft then returns to the original course via *CD*. Suppose the following results are obtained—

Original bearing  $270^\circ$   
 Bearing of aircraft when at *B*  $273^\circ$   
 " " " *C*  $266^\circ$

The average change in bearing is  $3\frac{1}{2}^\circ$  and the distance *BX* is 3 miles.

$$\begin{aligned}\tan BOX &= \frac{BX}{XO} \\ \therefore XO &= \frac{3}{\tan 3\frac{1}{2}^\circ} \text{ miles} \\ &= \frac{3}{.06116} \\ &= 49 \text{ miles.}\end{aligned}$$

Only one observation need be taken, if desired, and the deviation to *C* can be dispensed with. The method is, of course, only a rough one, but is useful in certain cases and provided the distance *OX* is moderate—not much more than 100 miles, because at greater distances the aircraft would have to make an undesirably large deviation from course to give a measurable change in bearing.

CHAPTER V

ERRORS IN D/F

IN the preceding chapters D/F processes have been considered without regard to practical difficulties or the various sources of error which arise. These will now be examined and the methods of dealing with them discussed.

**Vertical Error.** The figure-8 polar diagram of a frame aerial arises because the resultant E.M.F. in the frame depends upon the frame position relative to the direction of the transmitter, but the individual E.M.F.'s in the two sides are the same for any frame position, so that the signal is always "in" the frame, so-to-speak, and, unless precautions are taken, will go through the receiver and cause blurred or displaced minima. The effect is called "Vertical"

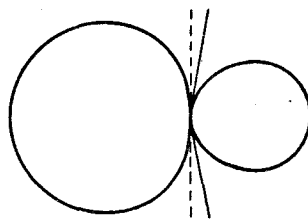

FIG. 48

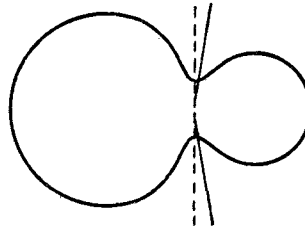

FIG. 49

because it is due to the frame aerial acting partly as an ordinary vertical aerial, thus superimposing a circle polar diagram on the figure-8. From what has been previously said, it will be seen that if the "vertical" current is in phase with the resultant frame current, the result will be a "cottage-loaf" polar diagram, the minima being sharp but displaced. This is shown in Fig. 48, the dotted line being the correct minimum position.

If the "vertical" current is out of phase with the resultant frame current, the minima will become "woolly" and also be displaced. (Fig. 49.)

The circuit action which gives rise to vertical error can best be understood by considering a simple frame aerial connected directly to the first valve of the D/F receiver.

This is shown in Fig. 50. Regarding the frame as a pair of spaced open aerials and assuming it to be in the correct minimum position with regard to some signal, it is clear that the points *A* and *B* will be at equal oscillatory potentials above earth. Now the impedance of *A* to earth is less than the impedance of *B* to earth because the

grid/cathode impedance of the valve is in series with the *B* side. Consequently, even though the frame is at 90° to the direction of the signal, there will still be a signal voltage between grid and cathode. The root cause of vertical error is, therefore, unbalanced impedances on the two sides of the frame and the elimination of vertical error consists of removing this lack of symmetry in the loop circuit. The methods are as follows.

1. DIFFERENTIAL OR BALANCING CONDENSER

Fig. 51 shows the insertion of a 3-plate differential condenser, the moving plate being earthed. Its effect is to alter the distribution

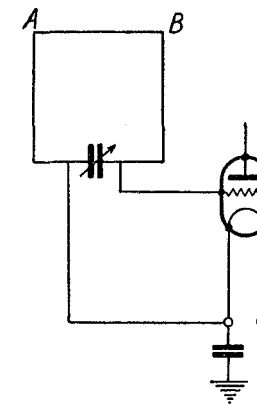

FIG. 50

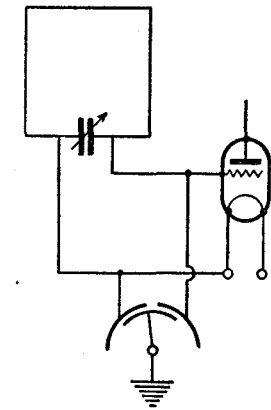

FIG. 51

of capacity between the two sides of the frame and earth and hence to effect a balance.

If an out-of-phase vertical component is present, better results may be obtained by introducing a balancing signal from the sense aerial, and this is often done, a typical circuit arrangement being shown in Fig. 52.

The variable coupling between the coils serves as an adjustment for best results. It may also act as a "zero-sharpening" device; this will be referred to again shortly.

2. EARTHED CENTRE-POINT OF FRAME

This is very effective, the circuit being as shown in Fig. 53. Assuming the frame to be at 90° to the direction of the signal, there will be no resultant current in the frame, the point *X* is at earth potential (ignoring the small inductance of the earth lead) and the impedances to earth of the two sides of the frame are obviously equal. The result is not quite perfect, however, because although *X* is at earth potential, the points *A* and *B* are not, owing to the potential gradient along the coils. There must necessarily be capacity

between the frame and the input circuit, shown by the "phantom" condensers *CC* in Fig. 53, so that energy can be transferred to the receiver via this capacity, thus re-introducing the out-of-balance effect of Fig. 50, but in a very much milder form.

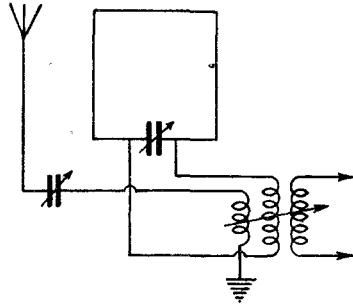

FIG. 52

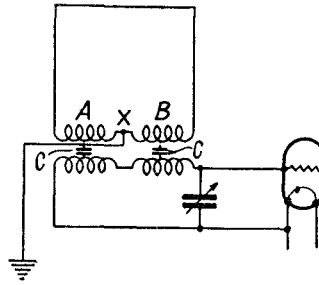

FIG. 53

### 3. THE SHIELDED TRANSFORMER

In this method the frame circuit is coupled to the first valve through a radio-frequency transformer, the windings of which are electrostatically screened from each other by the insertion of thin copper foil, which is earthed. (Fig. 54.)

For practical purposes copper is a non-magnetic material and therefore does not affect the normal transformer action. The presence of the shield, however, prevents any capacity between the windings, so that any energy transferred to the intermediate circuit as described for Fig. 53 cannot penetrate to the valve side of the transformer. The combination of earthed centre-point and shielded transformer is sufficient to eliminate any inherent error due to in-phase vertical.

### 4. THE SCREENED LOOP

This method is commonly used on aircraft and ships. In addition to assisting in the suppression of vertical error it also provides a convenient and rigid housing for the turns of the frame aerial, which is usually of circular shape in this class of work.

As will be seen from Fig. 55, the frame winding is enclosed in a metal tube which is earthed. The tube must not be continuous or it would form a closed single-turn coil tightly coupled to the frame and absorb a great deal of the signal energy. It is therefore broken at the top by an insulator *A* and becomes equivalent to two very short open aeriels which will have a high impedance to the signal frequency. The capacities of the two sides of the frame to earth now consist almost entirely of their capacities to the screening tube, thus largely nullifying the capacity unbalance at the valve. Twin loops at  $90^\circ$  to each other can be used for B.T. aeriels and are called crossed loops. The arrangement is weather-proof and very robust,

but as far as the cure of vertical error is concerned, a balancing condenser or shielded transformer is usually fitted in addition.

**Direct Pick-up.** Since the directional properties of a D/F station are vested solely in the aerial system, it is clearly imperative that no other part of the receiving apparatus should be affected by the wave. If it is, a small circle polar diagram will be superimposed on the figure-8 and the result will be much the same as vertical. The cure for this possible fault is very simple and consists of complete screening of the whole of the receiving gear other than the aeriels, i.e. the

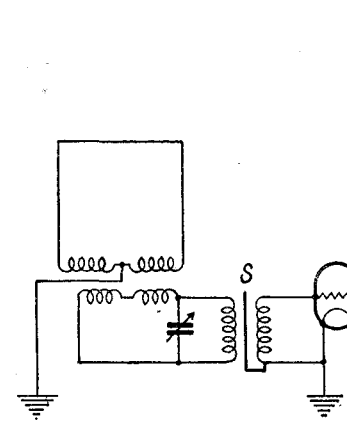

FIG. 54

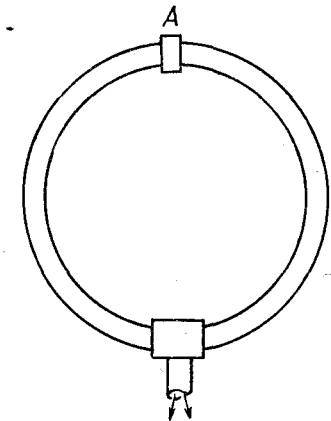

FIG. 55

receiver and the goniometer are built into metal cases which are earthed, and the lead-in wires from the aeriels are screened cable.

**Displacement Error.** When a frame aerial has more than one turn the depth of the winding is equivalent to a small frame at  $90^\circ$  to the main frame.

The box-type frame in Fig. 56, when at  $90^\circ$  to a signal, still has an effective spacing *d* and a signal would be received on this "loop" aerial, the capacity between the turns of the winding completing the oscillatory circuit. The displacement error thus arises through the frame turns not being coplanar, and a small figure-8 diagram is superimposed on the main figure-8, their major axes being at right angles to each other.

Fig. 57 shows the effect. The minima are not displaced, but are no longer zero and their sharpness is reduced. The extent of the swing required when taking a bearing would be very considerably increased.

In practice, the dimension *d* in Fig. 56 is very small compared with the frame diameter and, in the case of large single-turn B.T. loops, is negligible.

**Quadrantal Error.** This is also called "quadrature effect" or "site error." It is not due to any inherent defect in the loop but



arises from the presence of nearby conductors. The term conductors in this connection embraces such objects as wire fences, trees, power cables, railway lines, underground pipes, etc. All these are capable of having currents induced in them by a signal and will re-radiate. The aerial system of the D/F station may, therefore, be influenced by such re-radiation, and the spurious waves may have any phase relationship to the signal proper. Such a state of affairs will, of course, have disastrous results to the figure-8 diagram and will produce blurred or badly displaced minima. As regards ground D/F stations, the solution lies mainly in choice of site, which must be as free as possible from all offending conductors, and on a first-class site the quadrantal error is often negligible. A ship is never a

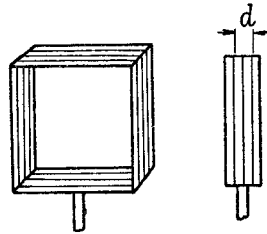

FIG. 56

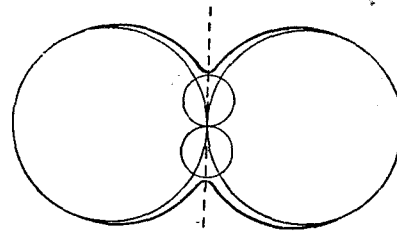

FIG. 57

good site for a D/F station, and an aircraft is, if anything, worse. This is due to re-radiation from the metal-work and rigging of the surrounding structures.

The only method of dealing with large quadrantal errors is the preparation of an error chart from which observed bearings can be corrected. This will be discussed more fully in a later chapter.

**Zero-sharpening.** If out-of-phase quadrature effect causes blurred minima, it is possible to sharpen *one* of them by a circuit similar to that of Fig. 52. The quadrature effect is equivalent to another and weaker signal arriving from the same transmitter, but in a different direction. A small figure-8 diagram is therefore superimposed on the main figure-8.

Fig. 58 (a) shows the resultant polar diagram, which is constructed taking into account the quadrature phase relationship between the E.M.F.'s, i.e.

$$OR = \sqrt{OP^2 + OQ^2}$$

The introduction of a vertical component via the sense aerial as in Fig. 52 will superimpose a small circle diagram, the E.M.F. being in phase with the quadrature E.M.F. owing to the magnetic coupling between the coils. This circle and the quadrature figure-8 thus combine to form a heart-shape diagram, and the combination of this heart-shape with the original figure-8 of the frame gives a diagram having *one* sharp minimum. (Fig. 58b.)

The curves in Fig. 58 (b) are as follows—

1. True figure-8 polar diagram of frame.
2. Quadrature polar diagram for re-radiated signal.
3. Vertical component from sense aerial.
4. Heart-shape resulting from 2 and 3.
5. Final result, combining 1 and 4.

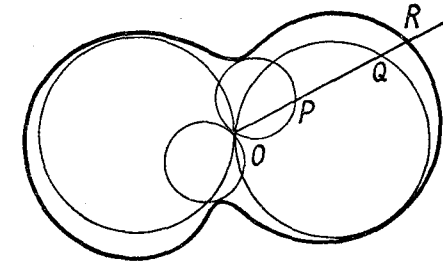

(a)

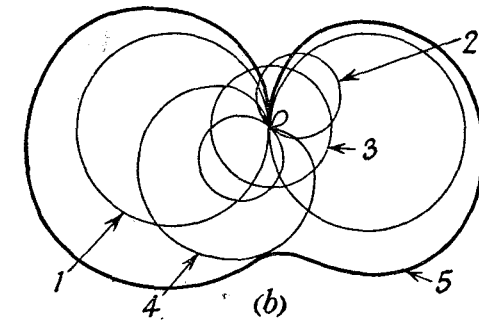

FIG. 58

Another type of zero-sharpening circuit is shown in Fig. 59 enables either minimum to be sharpened, because the vertical current can be deflected through either half of the coupling coil by adjustment of the differential condenser. This reverses the heart-shape diagram of Fig. 58, and hence sharpens the opposite minimum. It will sometimes be found that zero-sharpening devices shift the minimum very slightly when used at the extremities of their range, but this does not usually exceed a degree. The effects illustrated in Fig. 58 are much exaggerated in order to make the diagram clear.

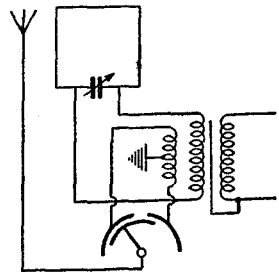

FIG. 59

**Night Effect.** A fixed transmitting station should of course always give the same result when its bearing is taken by a fixed D/F station. Very early in the history of D/F, however, it was noticed that the apparent bearings of fixed stations went through astonishing variations, sometimes being  $90^\circ$  or more out. On medium wave-lengths, say 300 metres upwards, these phenomena were found to occur mostly during the period between dusk and dawn, the daylight hours being comparatively free from any irregularity, thus giving rise to the term "night effect."

During the Great War, 1914-1918, it was also noticed that at short ranges the apparent bearing of an aeroplane from a D/F

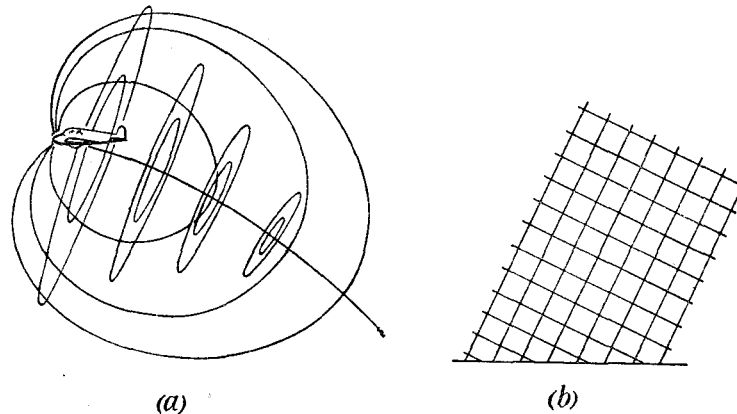

FIG. 60

station was subject to very large errors, and that these errors varied according to whether the aeroplane happened to be flying directly towards or away from the D/F station or in some other direction. This was called "aeroplane effect" and the explanation is as follows.

Referring to Fig. 6 (b) this is called a normally polarized wave. In the case of an aeroplane flying at a height which is an appreciable fraction of its distance from the D/F station, the wave is arriving at a downward angle, and also may be abnormally polarized, i.e. the lines of force of the magnetic field may not be horizontal. That this may be so is easily seen if the field distribution round an aircraft aerial is considered.

Fig. 60 (a) shows the lines of electric and magnetic force surrounding a trailing aerial, and (b) a possible appearance of the wavefront as presented to the D/F station.

*When abnormal polarization accompanies a vertical angle of incidence, an error is bound to occur.*

The action of such a wave on a frame aerial is difficult to explain in words and still more difficult to illustrate diagrammatically, but

can be shown very clearly by means of the simple model illustrated in Fig. 61.

The flat disc  $D$  is ruled with a series of lines at  $90^\circ$  to each other to represent the magnetic ( $M$ ) and electric lines of force ( $E$ ) associated with the wave. The rod  $R$  is fixed at right angles to the surface of the disc and represents the direction of travel of the wave, these three directions being of course always mutually at right angles. (See Fig. 6a.)

By using a flat rectangular object such as a post-card to represent a receiving frame the effect of different angles of incidence and degrees of polarization can be examined.

CASE 1. It is instructive to consider first the results of horizontal polarization, i.e. when the lines of force of the electric field are

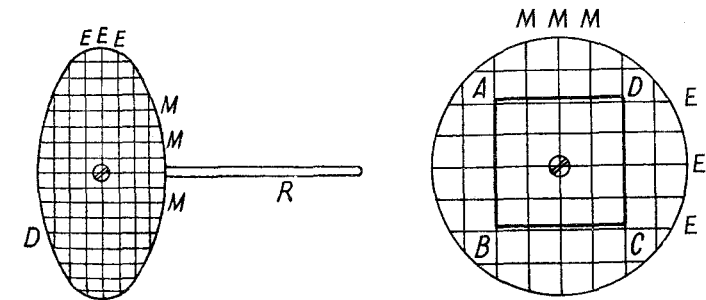

FIG. 61

FIG. 62

horizontal and the magnetic field is vertical, the direction of wave travel being taken as parallel to the ground and, therefore, at  $90^\circ$  to the plane of the frame.\*

This is shown in Fig. 62, in which  $ABCD$  represents the frame aerial.

The vertical limbs  $AB$  and  $CD$  now have zero flux linkage, consequent upon the horizontal polarization, but the horizontal limbs  $AD$  and  $BC$  are cut by the magnetic flux. The frame thus has its directional properties converted to depend upon the spacing of the horizontal limbs, and rotation of the frame about a vertical axis would have no result, the signal remaining at zero.

Now assume that the wave (still horizontally polarized) arrives at a downward angle instead of horizontally.

Fig. 63 is a side view of the disc and card adjusted to represent these conditions. Ignoring for the moment which direction is vertical and which horizontal, it is clear that the frame is not in the minimum position relative to the wave but will receive a signal proportional to the cosine of the angle between  $AB$  and  $MM$  in

\* Note. The polarization of a wave is conventionally described with reference to the position of the electric field. In a normal wave the electric field is vertical (Fig. 6b). "Normal" polarization or "vertical" polarization, therefore, means the same thing.

Fig. 63. Recalling now that  $AB$  is actually one of the vertical limbs of the frame, it will be seen that rotation of the frame about a vertical axis in an attempt to do D/F will result in a minimum when the frame is in the position of Fig. 64, thus giving a  $90^\circ$  error.

Summarizing these facts, it can be stated as a generalization that any horizontally polarized wave arriving at a downward angle will

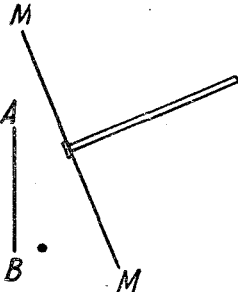

FIG. 63

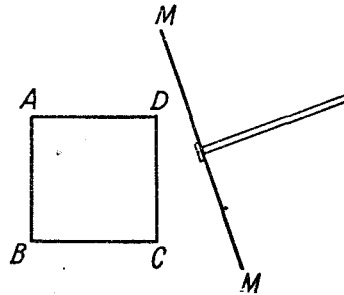

FIG. 64

cause a  $90^\circ$  error in D/F with a simple frame, because the signal is received on the *horizontal* limbs of the frame instead of the vertical.

CASE 2. If the wave is normally polarized—magnetic lines of force horizontal—but has a downward angle, no error will occur, the position being as in Fig. 65.

$AB$  is a side view of the frame and  $M$  represents an end view of a

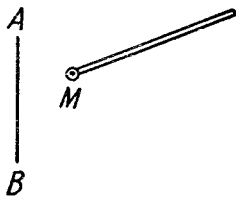

FIG. 65

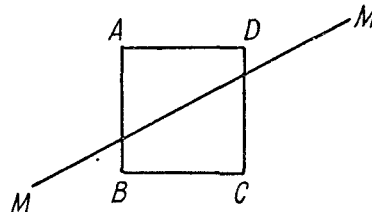

FIG. 66

line of magnetic force. No E.M.F. can be induced in the horizontal limbs and the position of the frame for zero flux linkage is correct.

CASE 3. If the wave is abnormally (but not horizontally) polarized and is approaching horizontally, again no error will occur.

This is shown in Fig. 66, which is a front view of the frame.  $MM$  represents a line of magnetic force approaching horizontally but tilted due to abnormal polarization. No E.M.F. can be induced in the horizontal limbs and the position of the frame for zero flux linkage is correct.

CASE 4. Abnormal polarization with a downward angle of approach.

It is practically impossible to represent this condition clearly on a flat diagram, but manipulation of the post-card and model of

Fig. 61 will at once show that when these circumstances arise, the frame has to be turned away from the correct minimum position in order to obtain zero flux linkage, and that the plane of the frame is then no longer at  $90^\circ$  to the direction of travel. Nor does the trouble end here, because there will also be E.M.F.'s induced in the horizontal limbs of the frame, and the position of the minimum will be decided by these two factors together with several other less determinate ones, the whole situation becoming quite hopeless for D/F.

An elementary analysis of the main points is as follows.

A tilted magnetic line of force approaching at a downward angle can be resolved into two components—

(a) A normally polarized (horizontal) component, which will give correct D/F.

(b) A vertical component which tends to give a  $90^\circ$  error, because it influences the horizontal limbs of the frame. (See Fig. 63.)

As a convenient reference, the term "standard wave error" has been introduced. The standard wave error of any particular system of D/F aerials is the error resulting when the angle of tilt (polarization) and the downward angle of approach are both  $45^\circ$ . For a simple rotating loop aerial with dimensions small compared to a wave-length, all bearings will be displaced about  $35^\circ$  under these conditions.

From the foregoing it will be seen that the errors coming under the general term "night effect" can be attributed to one final cause—the spurious E.M.F.'s induced in the horizontal members of a frame under certain conditions. The most direct method of combating the error is, therefore, the elimination of the horizontal members, and although other methods are possible, none has been generally adopted.

**The Adcock Aerial System.** This system was first proposed by Adcock during the War, 1914–1918, and is now practically standardized for permanent ground D/F stations.

The principle of the Adcock aerial is the removal of the top horizontal limb of the frame, which thus becomes a pair of spaced open aerials, and the careful screening of the bottom horizontal limb so that it is not affected by the wave. This is not nearly so easy to effect in practice as it might appear to be, and a considerable number of different and more or less complex circuit arrangements have been tried. It is beyond the scope of this book to go deeply into the theory of the Adcock aerial, and only two of the more commonly used types will be described.

**The Buried U Type.** The general lay-out is shown in Fig. 67, the coil being one of the stator coils of a radiogoniometer. (Although the Adcock system is theoretically applicable to a rotating frame, it has been applied almost exclusively to B.T. aerials, chiefly because the B.T. principle has practically superseded the rotating frame except for aircraft and small portable D/F sets.)

The lower portion of the Adcock aerial is buried to a depth of 2 to 6 feet, the depth chosen depending upon conductivity of the soil and aerial spacing. When the soil conductivity is poor, better results are obtained by the addition of an extended earth continued for a distance up to about 100 feet from the centre. The standard wave error for this type of Adcock system is about  $6^\circ$  or  $7^\circ$ , which, of course, is a very great improvement.

**The Coupled Type.** Fig. 68 shows a type of Adcock aerial circuit which gives still better results. It is understood, of course, that the coupling transformers and intermediate circuit are completely

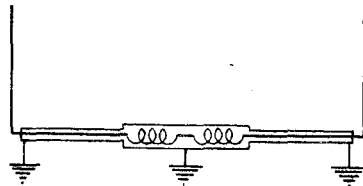

FIG. 67

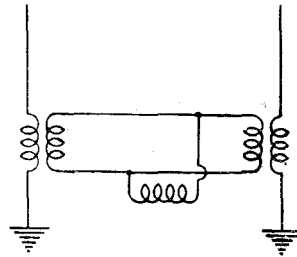

FIG. 68

screened and the leads connecting them buried as previously described. The standard wave error is reduced to about  $2^\circ$ .

**Causes of Downward Angle of Incidence.** It has been shown that the cause of "night effect" is the arrival at the receiving frame of an abnormally polarized wave having some vertical angle of incidence. The production of such a wave is easily understood in the case of an aeroplane, but the question naturally arises as to how these conditions can occur when a wave travels between two points both of which are on the surface of the earth. The explanation was provided by the discovery of a series of layers of ionized air which act as reflectors to electromagnetic waves radiated at an upward angle from a transmitting aerial, the lowest of these layers having been predicted independently by Heaviside and Kennelly. A second layer at a higher level was discovered by Appleton, and these two are often referred to as the "E" and "F" layers respectively. The average height of the "E" layer is considered to be about 100 kilometres and that of the "F" layer about 250 kilometres.

There are various causes of ionization in the upper atmosphere, of which the most important is probably solar radiation. The degree of ionization, the height of the rather ill-defined underside of each layer, and the depth of the layers are all subject to daily and seasonal variations. The possibility of a wireless wave being reflected back to earth is governed by a number of factors, as follows—

- (a) Time of day or night.
- (b) Season of year.

- (c) Presence of sunspots.
- (d) Frequency concerned.
- (e) Latitude of the transmitter.
- (f) Type of transmitting aerial.
- (g) Angle at which the upward radiation travels.

The whole matter is thus one of great complexity, and detailed discussion of it is beyond the scope of the present work. It may be noted, however, that a large number of data are available on the subject, and it is now possible to select an appropriate frequency for communication between any two points at any time of the day or night, whatever the distance involved may be.

**Direct and Indirect Ray.** A direct ray means radiation which travels direct from transmitter to receiver over the surface of the earth. Such a ray is always normally polarized, because it is not possible for an abnormally polarized wave to travel over sea or land in that condition. The reason for this can be seen from Fig. 69.

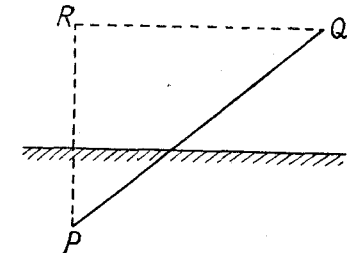

FIG. 69.

$PQ$  represents a magnetic line of force travelling towards the observer. This can be resolved into two components,  $RP$  and  $RQ$  at right angles.

$RQ$  is parallel to the ground and is therefore the normally polarized component.

$RP$  is vertical and is, therefore, cutting the surface over which the wave is passing and setting up induced currents in the ground. The wave cannot travel far before all the energy in the vertical component of the magnetic field is dissipated, leaving only the normally polarized component. Experiments have shown that this return to normal polarization occurs within a few wave-lengths of the transmitting aerial.

Abnormal polarization is thus associated only with waves which are travelling in free space or which have been reflected from the upper atmosphere.

An aeroplane at short range may produce a wave which is still abnormally polarized at the ground D/F station because at short ranges the downward angle is comparatively large. When, however, the height of the aeroplane is only a small fraction of its distance from the D/F station, the wave travels practically horizontally and normal polarization is quickly restored as just described.

The indirect ray means a wave arriving at the receiving station after one or more reflections in the upper atmosphere.

Fig. 70 shows three possible ways in which a wave may travel from a transmitter  $T$  to a receiver  $R$ . The path  $A$  is called a first order reflected ray, and  $B$  is a second order reflected ray, the wave having been reflected twice by the upper atmosphere and once from the

surface of the earth. Whether such reflection takes place in any particular case and at what downward angle it arrives depend upon all the variable factors previously mentioned, but in general, the shorter the distance between transmitter and receiver the less is the likelihood of anything other than the direct ray being received. The practical significance of this is that ordinary rotating loop D/F or B.T. stations not using Adcock aerials are confined to short-range working except during full daylight hours (medium frequencies).

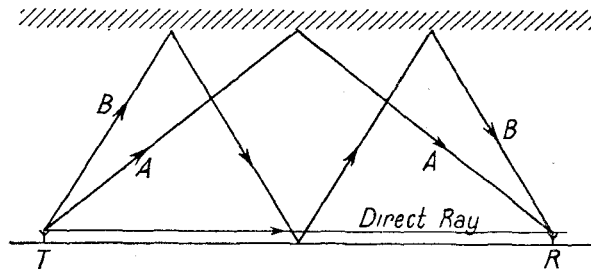

FIG. 70

At other hours it is not advisable to place any reliance on bearings taken at a greater range than about 20–30 miles, and even these may not always be above suspicion.

**Symptoms of Night Effect.** Fortunately, the presence of a reflected and abnormally polarized wave is usually detectable by one or more of the following symptoms—

- (a) *Minima suddenly become woolly.*
- (b) *Minima are sharp but displaced.* This of course is the most dangerous form of night effect, and could not be detected if it occurred with no other symptom. By taking a bearing on a known fixed transmitter, the error might appear, but neither its presence nor absence would be conclusive because a reflected ray might occur from one direction at a certain distance but not from a different direction and distance.
- (c) *Distortion of broadcast programmes.* This is a certain symptom of the presence of a reflected ray and the effect is well known. A speaker is apparently being strangled and hideous disharmony replaces music.
- (d) *Fading of the signal.* Such fading may be slow or rapid, but unless very slow it will be noticeable.
- (e) *Distortion of the heart-shape.* This is a valuable method of detecting night effect. In some cases the distortion is not very marked, but often it is at once apparent if the search coil is swung through a complete 360° in the Sense position. A D/F operator should make a point of getting thoroughly familiar with the "sound" of a normal heart-shape, so that he will be able to observe even comparatively small deviations from it.

**Fading.** The fading of a signal is due to interference between the direct ray and one or more reflected rays. Since the path of the reflected ray is longer than that of the direct ray, the two waves may have any phase relationship at the receiving aerial, and this phase relationship may change from moment to moment. If the two waves are equal and anti-phased there will, of course, be no signal while this condition lasts. An in-phase condition will produce an artificially strong signal. Intermediate phasing will modify the signal strength to some extent and also cause the distortion of modulated waves mentioned at (c) above.

**Skip Distance.** For any transmitter, the ground (direct) ray eventually becomes too weak for reception, the distance at which this occurs depending mainly upon the power of the transmitter. If reflection takes place, reception again becomes possible where the reflected wave first returns to earth. It follows that there may be a

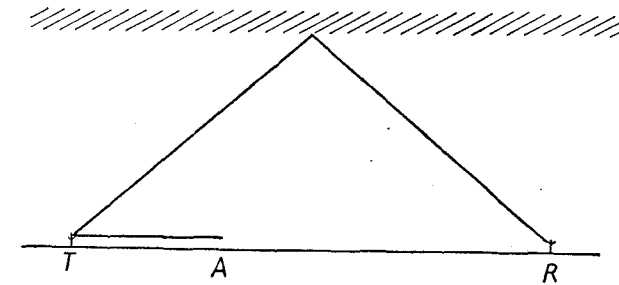

FIG. 71

space in which the signal cannot be heard, points in this space being too far away to receive the direct ray and not far enough to receive the first reflection.

In Fig. 71  $T$  represents the transmitter, and  $TR$  is the maximum range of the direct ray. If the first reflection returns to earth at  $R$ , the region  $AR$  is called the skip distance and no signals will normally be received in it.

A D/F station at  $R$  or beyond can receive the signal by the reflected wave only and can give D/F service provided the station is equipped with an aerial system free from polarization error—in most cases Adcock aerials.

It should be noted in passing that all long-distance radio-communication takes place by means of the reflected ray, many reflections often being involved for really great distances approaching the possible limit of about 12,000 miles (half the Earth's circumference).

The distances at which the reflected ray first returns are fairly accurately known for most combinations of frequency, latitude and time of year, and "skip curves" have been constructed to give this information in graphical form.

**Scatter Sources.** It is sometimes contended that the phenomenon

of skip is a myth, because signals do occur within a skip area, especially if the power of the transmitter is, say,  $\frac{1}{2}$  kw. or more. When, however, bearings are taken on such signals, even with an Adcock system, the minimum is often extremely vague and in any case has no relation to the correct bearing. This shows that some other agency is at work, by which the wave is reflected in some random direction and may reach a receiver in the skip zone. These agencies are known as scatter sources. There is not much likelihood of trouble with scattered radiation in carrying out D/F with aircraft, because the power of the aircraft transmitter would not be sufficient to produce the effect, and, fortunately, the errors in a bearing taken on scatter sources are nearly always so absurdly large that they would be at once rejected in normal circumstances—in quite a large percentage of practical cases the D/F operator has some idea of what the bearing should be. Even in the worst case where the ground D/F operator is actually deceived there is a further safeguard in that a ship or aircraft is very rarely so hopelessly lost that the captain would act on a D/F bearing that is  $90^\circ$  or more out. The danger is still less when the D/F station forms one of a group providing a fixing service, because the error will be at once apparent when an attempt is made to obtain an intersection of the bearings on the plotting map.

**Coast Refraction.** Many instances have been observed of errors of a few degrees occurring in D/F bearings when the line joining the

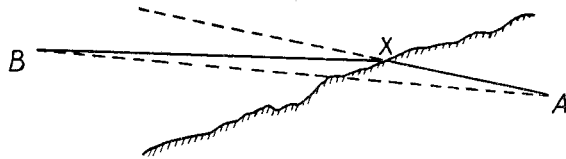

FIG. 72

ship or aircraft to the D/F station crosses a coast line at a fairly acute angle. This is attributed to refraction, i.e. a change in the path of the ray as it crosses the coast line, just as light waves have their direction changed when passing through water or glass.

In Fig. 72 *A* represents a D/F station and *B* a ship. The ray which actually reaches *A* follows the path *BXA*, so that the apparent bearing of the ship would be the line *AX* produced instead of the line *AB*, thus giving rise to an error represented by the angle *BAX*.

The coastal refraction error varies with frequency and to some extent with the distances involved, so that it is somewhat difficult to make allowances for it even though it exhibits constancy in a particular combination of circumstances. The practical result is that coastal D/F stations usually have a "doubtful sector" in which they either give no bearings or else give them all as third-class, however sharp the minima may be.

**Octantal Error Due to Aerial Spacing.** It was explained in Chapter II and shown in Fig. 20 that a frame aerial does not obey a true cosine law and give a twin-circle figure-8 polar diagram unless its diameter is about  $\frac{\lambda}{8}$  or less. On short-wave D/F, roughly between 10 and 100 metres, the frame diameter may be as much as  $\frac{\lambda}{2}$ , e.g. with an aerial spacing of 6 metres and a wave-length of 12 metres. With rotating frame D/F this would not matter because the position of the minimum is unchanged, although the figure-8 diagram has become two ellipses. With B.T. or Adcock aerials, however, an

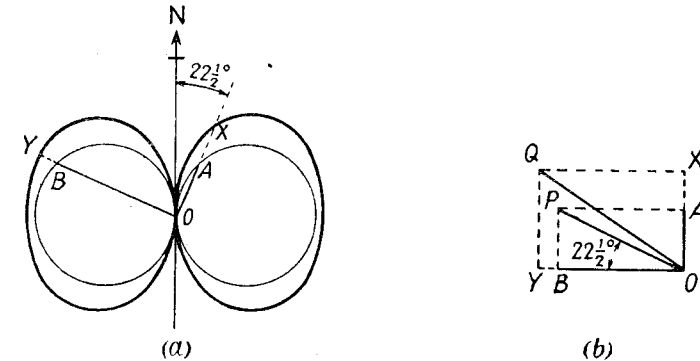

FIG. 73

error arises because the goniometer search coil has a true cosine law whereas the aerials have not.

No error will occur in the true North, South, East, or West directions because only one pair of aerials is then contributing to the goniometer field (assuming that the aerials are aligned N.-S. and E.-W.). No error will occur in any of the  $45^\circ$  positions, since the two pairs of aerials are then contributing equally to the goniometer field and symmetry holds good. Maximum error will occur at or very close to the  $22\frac{1}{2}^\circ$  positions, i.e. at  $22\frac{1}{2}^\circ$ ,  $67\frac{1}{2}^\circ$ ,  $112\frac{1}{2}^\circ$ ,  $157\frac{1}{2}^\circ$ , etc. The reason for this error can be seen if Fig. 73 is studied.

In Fig. 73 (a) two polar diagrams are drawn. The smaller one is a true figure-8, and it is supposed that it represents the polar diagram of the E.-W. frame or pair of Adcock aerials, the spacing being  $\frac{\lambda}{8}$  or less. Now imagine a signal to arrive on a true bearing of  $22\frac{1}{2}^\circ$ . The signal strength in the E.-W. aerial is shown by the radius *OA*. The signal strength in the N.-S. aerial will be given by the radius *OB*, the angle *AOB* being  $90^\circ$ .

(The same result would, of course, be obtained by superimposing an identical figure-8 diagram at right angles to the first and producing *OA* to meet it, but this leads to a confusing diagram.)

Fig. 73 (b) shows  $OA$  and  $OB$  re-drawn and the parallelogram law applied.  $OP$  is the resultant, and the angle  $POB$  will be  $22\frac{1}{2}^\circ$  as demonstrated in Chapter III with reference to the goniometer.

Now suppose the wave-length of the same signal is decreased to a point where the aerial spacing is considerably more than  $\frac{\lambda}{8}$ , the figure-8 diagram becoming two ellipses. This diagram is also shown in Fig. 73 (a) and it is clear that the contributions of the two aerials to the goniometer field will now be represented by  $OX$  and  $OY$ . Inspection shows that owing to the elliptical shape of the polar curves,  $OA$  has been increased in a much greater proportion than  $OB$ . Transferring these new dimensions to Fig. 73 (b) and again applying the parallelogram law, the resultant obtained is  $OQ$ , and the angle  $QOB$  is more than  $22\frac{1}{2}^\circ$ . The angle  $POQ$  thus represents the error due to aerial spacing.

As a practical illustration, the spacing error on an H/F D/F Adcock Station with an aerial spacing of 20 feet (6.1 metres) is  $\pm 1^\circ$  on a wave-length of 28 metres (10.7 megacycles). At 14 metres (21.4 megacycles) the error reaches  $\pm 5^\circ$ , and if the D/F station is to be used on frequencies of this order, corrections would have to be applied to observed bearings.

**General Note on Errors in D/F.** The student who is not yet a D/F operator may quite reasonably be somewhat appalled at the array of possible sources of error which have been discussed. From the operator's point of view, however, there is little need for alarm, because in modern D/F stations the residual errors are often so small that they can be neglected, or alternatively a correction chart is provided. At the same time a clear understanding of the errors associated with D/F is essential for intelligent use of the apparatus. Night effect remains as a more or less constant threat, since even an Adcock system is liable to large errors if the downward angle of approach is steeper than about  $60^\circ$ . A bearing which is  $90^\circ$  or more wrong is probably less dangerous than one which is  $20^\circ$  wrong, because whereas the former would most likely be ignored as impossible by the captain of an aircraft, the latter might be accepted and acted upon with disastrous results. In spite of careful D/F organization, co-operation with other D/F stations and the placing of final responsibility upon aerodrome control officers, some responsibility must always rest upon the D/F operator.

**Typical D/F Circuits.** There are many different ways of arranging the circuit details for D/F aerials and of securing circle, figure-8, and heart-shape reception, zero-clearing, and sense amplitude control. The general principles already discussed remain the same, but one or two typical schemes will be described.

Fig. 74 (a) shows a simple circuit suitable for B.T. aerials.  $S$  is the search coil and the coils  $L_1$   $L_2$  provide coupling between the open aerial and the search coil circuit. In the stand-by ( $SB$ ) position, the signal strength from the open aerial would be sufficient to swamp

any E.M.F. in the search coil, thus giving a circle polar diagram. In the D/F position the open aerial is earthed, and in the Sense position it is brought into circuit again through the phasing resistance  $R$ .

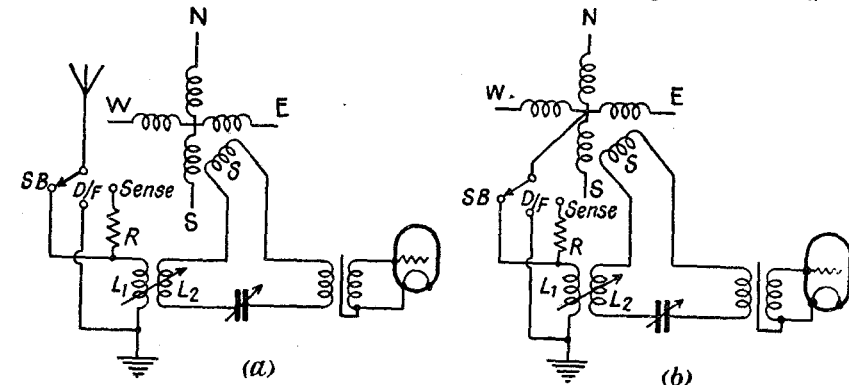

FIG. 74

The variable coupling between  $L_1$  and  $L_2$  will assist in obtaining a heart-shape balance.

Fig. 74 (b) is a similar arrangement but dispensing with a separate open aerial. The common centre point of the goniometer stator coil windings is taken to the stand-by, D/F, Sense switch. In the case of large B.T. frames the "vertical" effect will be quite sufficient to give circle or heart-shape reception as required.

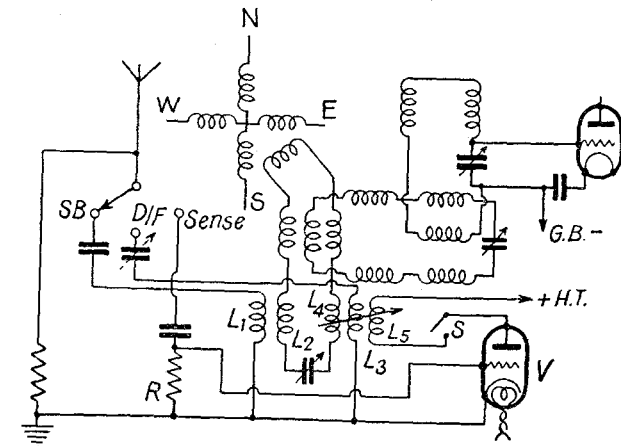

FIG. 75

Fig. 75 is a rather more complex input circuit for a medium wave Adcock installation. The complexity is, however, more apparent than real and arises from the special precautions taken to secure

symmetry in the search coil circuit and thereby avoid vertical error. In the stand-by position the open aerial is coupled to the search coil circuit through the coils  $L_1$  and  $L_2$ . In the D/F position the open aerial is again coupled to the search coil circuit via the coils  $L_3$  and  $L_4$ , but this coupling is much more loose and is made variable to act as a quadrature compensator, i.e. a zero-clearing device. Changing the switch to the Sense position converts the open aerial to an aperiodic circuit, the signal E.M.F.'s across the resistance  $R$  being fed to grid and cathode of the open aerial-coupling valve  $V$ . At the same time the switch  $S$  is closed, thus bringing the valve  $V$  into operation. Sense amplitude and hence the heart-shape quality are controlled by the variable coupling between  $L_4$  and  $L_5$ .

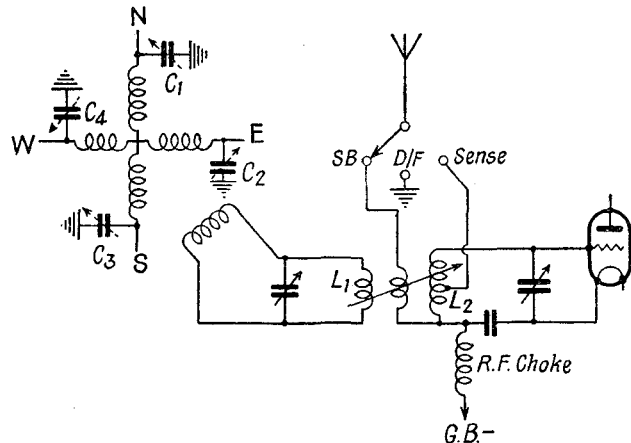

FIG. 76

Fig. 76 is the input circuit for a short-wave Adcock installation, and from what has been said previously the diagram will be self-explanatory. The variable coupling between  $L_1$  and  $L_2$  provides control for a heart-shape balance. The small pre-set condensers  $C_1$ ,  $C_2$ ,  $C_3$ , and  $C_4$  are for the purpose of balancing the aerials on installation in order to compensate for slight aerial inequalities and any unbalance effects due to wiring and switches.

In H/F D/F apparatus these precautions are necessary because the size and spacing of the aerials is much larger compared to a wave-length than is the case on medium or long waves.

The method of adjusting the balancing condensers is briefly as follows—

1. Turn all condensers back to zero. (A long insulated screwdriver should be used.)
2. Place a local oscillator in line with the N.-S. masts and two or three wave-lengths distant.
3. Observe bearing and gradually increase wave-length in small

steps, checking bearing at each change. It may be found that at one particular wave-length an error will occur, usually when the overall length of each Adcock U is about  $\frac{3}{4}\lambda$ .

4. Having found the tuning point at which the largest error occurs, adjust the balancing condensers on the E.-W. stator coil until the error is eliminated. The adjustment is very critical and must be done with care, removing the screwdriver each time a check bearing is taken.

5. Repeat the process on each cardinal point, adjusting the N.-S. balancing condensers when the oscillator is east or west.

6. If the wave-length range of the set includes a figure at which the Adcock U's would be about  $1\frac{1}{2}\lambda$ , it will be necessary to balance again for the 45° positions, N.E., S.W., etc. Corrections in this case are made by small *equal* increases in capacity on either the N.-S. or the E.-W. balancing condensers.



## CHAPTER VI

## SITING AND CALIBRATION

**Choice of Site for D/F Station.** Although the choice of site for a permanent D/F station of major importance would not be a matter for the D/F operator, he might in some cases be called upon to select a site for a temporary or portable D/F station, and it is as well to memorize the general principles.

The selection of a site is nearly always difficult because it can rarely if ever be done with singleness of purpose. A good site may have to be discarded because higher authority requires it for other purposes, or because it is too far from or too near to the aerodrome, or because it is inaccessible, or because it presents administrative difficulties. Sanitation, the transport of personnel, food and water supplies, batteries, fuel, spares, and stationery, all have to be considered in conjunction with what ought to be the sole criterion of a site—freedom from sources of error. The result is almost inevitably a compromise, and every particular case must be dealt with on its own merits. It will be sufficient here to consider some of the more important technical points only. The type of D/F station is assumed to be rotating frame, B.T., with small crossed loops or short-wave Adcock having an aerial spacing of 20 to 30 feet.

First, the site must be as far away as possible from the following objects—

(a) Buildings, especially those of steel construction. Wooden huts do not matter so much, but if they have electric lighting, the wiring may cause errors.

(b) Trees, particularly tall ones, or clumps of trees whatever their height.

(c) Railway lines.

(d) Overhead power and telephone cables.

(e) Wire fences.

(f) Receiving or transmitting aerials.

(g) Underground sewers or conduits.

(h) Main roads. If a short-wave D/F station is close to a main road, ignition interference from passing vehicles may be so severe that the station could not be used. This trouble, however, does not occur on medium or long waves.

The ground chosen should be reasonably flat and be approximately the highest point in the immediate neighbourhood. A D/F station in a valley would be almost certain to have large errors.

Soil having good conductivity is most desirable; ordinary grass-land is generally satisfactory. Fairly soft ground also facilitates the digging of trenches for an Adcock system or the provision of buried earth plates for B.T. or rotating loop.

The position of the transmitter may also have some influence on the site for a temporary D/F station, according to whether it is intended to install keying, telephone, and power lines of a permanent nature or to use temporary cables. The keying and telephone lines will, of course, be essential in any case, but electric power to the D/F station may be dispensed with if the D/F receiver is designed to work from batteries.

**Orientation of Masts.** The site having been selected, a stake is driven into the ground to mark the centre of the station, and the next step is to find and mark the direction of True North. There are more than a dozen different ways of ascertaining this, some of them based upon astronomical observations, but for the purpose being considered one of two methods is sufficiently accurate, and these will be described.

## (a) COMPASS METHOD

A good-quality compass is all that is required. The kind known as a "landing" compass is quite suitable, this being somewhat similar to an aircraft compass and mounted on a tripod with telescopic legs for levelling.

Fig. 77 shows the method of use. The compass is placed directly over the stake marking the centre of the station so that the plumb-line coincides with the centre of the stake, levelling of the compass being carried out simultaneously. All magnetic materials must be removed to a reasonable distance, say 20 yards, including any keys, tools, etc., in the pockets of the user. The compass reading for True North will be  $000^\circ$  plus or minus the local magnetic variation.

Thus, assuming the local magnetic variation to be  $10^\circ$  west, a compass reading of  $10^\circ$  will indicate True North. The verge ring on the compass is set to read  $10^\circ$  and a "ranging pole" is used to mark the True North line.

A ranging pole is a straight wooden pole about 6 feet long, and this is held vertically by an assistant at a convenient distance, say 10 to 15 yards from the centre stake. The person using the compass then directs the alignment of the pole until it is covered by the compass sights. A second ranging pole placed a further short distance away will tend to improve accuracy if both are aligned.

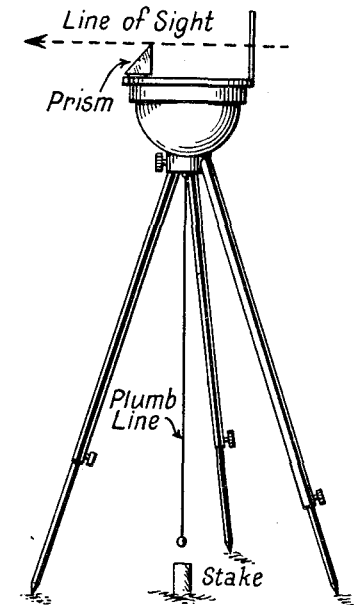

FIG. 77

If the station is an Adcock type, the position of the North mast can now be marked by measuring off the appropriate distance along the North line. The position of the South mast is best found by using a third ranging pole and carefully aligning it with the other two. The alignment of ranging poles can be carried out with great accuracy, especially if the person directing the aligning process uses a pair of field glasses.

Fig. 78 shows this step in plan.  $O$  is the centre of the station.  $B$ ,  $C$ , and  $D$  are ranging poles,  $A$  is the observer, and  $X$  and  $Y$  are the mast positions

The marking of the E.-W. mast positions is the next step. The compass reading for True East, assuming the same magnetic variation, will be  $100^\circ$ , and the process is repeated as described for the N.-S. line.

It should be remembered that for a B.T. or Adcock system it is absolutely imperative that the frames or pairs of Adcock aerials

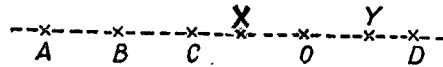

FIG. 78

should be exactly at  $90^\circ$  to each other, whereas it matters very little if they are not exactly N.-S. and E.-W. The Adcock masts will lie at the corners of a square, and careful checks must be made to verify that this is so.

In Fig. 79,  $A$ ,  $B$ ,  $C$ , and  $D$  represent the mast sites. Measurement should show that the distances  $AC$ ,  $BC$ ,  $BD$ , and  $DA$  are all the same. A further test to prove that the angles at  $O$  are  $90^\circ$  can be made by marking off  $OP$  equal to 4 units (say 8 feet), and  $OQ$  equal to 3 units (6 feet). From the right-angled triangle  $POQ$  it follows that  $PQ$  should be 5 units (10 feet).

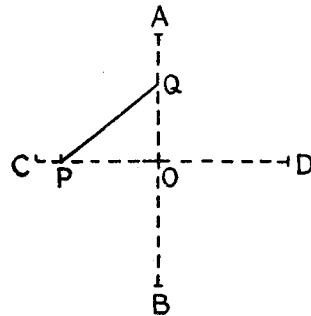

FIG. 79

As a general principle, measurement rather than the compass should be relied upon for determining the E.-W. line, though the compass can be used alone for determining a supposed N.-S. line.

#### (b) MAP METHOD

This method requires a theodolite or sextant together with a large-scale Ordnance Survey map of the district—6 inches to 1 mile is suitable. The position of the D/F station is marked as accurately as possible on the map. This will probably involve measurement of distances from the central stake to the nearest fence or hedge and their application to the map after multiplying by the representative fraction.

The next step is to choose two or three conspicuous objects which can be seen from the D/F site and are also included on the map. Factory chimneys, church spires, or the corners of a large building are suitable. The bearings of these objects from the D/F site are then measured on the map by a protractor. An important point here is never to assume that the *edges* of the map represent either meridians or parallels—this is very rarely the case.

The theodolite is then placed over the stake marking the centre of the D/F station and a ranging pole set up to give the required angles.

Fig. 80 shows the scheme.  $O$  is the central stake, and  $OX$ ,  $OY$ ,  $OZ$  are the bearings of three prominent objects, each of which should be not much less than a mile away.

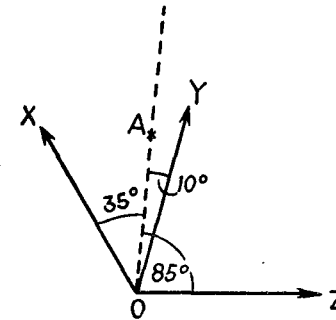

FIG. 80

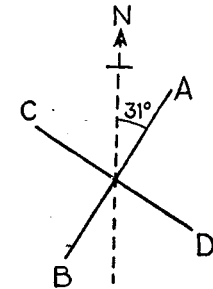

FIG. 81

For illustration, bearings of  $35^\circ$ ,  $10^\circ$ , and  $85^\circ$  have been taken.  $A$  represents a ranging pole which is moved under the direction of the person using the theodolite or sextant until the three angles are correct. This fixes the N.-S. line and the E.-W. line can then be laid down by a combination of theodolite or sextant observations and geometrical checks as previously described.

The map method is probably more accurate than the compass method unless the compass used is a very good one. On the other hand, there may be difficulty in obtaining 6 inch Ordnance Survey maps and a theodolite or sextant may not be readily available.

In cases when a D/F station has to be erected in a hurry and no means of finding True North are at hand, it is quite sufficient to lay out the mast positions at  $90^\circ$  to each other without considering their orientation, adjustment being made subsequently on the goniometer pointer.

Thus in Fig. 81 suppose the masts have been set up at random as regards direction, and it was afterwards found that the "N.-S." aerial  $AB$  was at  $31^\circ$  to True North, the E.-W. aerial being of course at  $121^\circ$ . Apart from other possible errors, a signal from True North would give a reading of  $360^\circ - 31^\circ = 329^\circ$  on the goniometer. The D/F pointer must therefore be moved *forward*  $31^\circ$  on the scale.

**Calibration of Ground D/F Station.** When the station is complete and in working order, the determination of any residual errors is undertaken. This process is called calibration. The same general principles apply to the calibration of any D/F station, and the methods employed for an aerodrome D/F will now be described.

### 1. PRELIMINARY CALIBRATION WITH LOCAL OSCILLATOR

Local oscillators for this purpose are small calibrated oscillatory circuits driven by a single valve from batteries and with a short vertical rod aerial 3 feet to 4 feet long. The oscillator and batteries should be completely enclosed in a metal box so as to ensure that the radiation comes from the aerial only and abnormal polarization effects are absent. The method of calibration is to place the oscillator at a number of points in turn, the bearings from the D/F station differing by about  $10^\circ$ . The distance should not be less than 100 yards, and if rather greater distances are practicable it is better to use them. At each point simultaneous compass bearings and D/F bearings are taken and the results tabulated. An error chart is not prepared at this stage, however, because calibration with a local oscillator cannot be regarded as conclusive. It does, however, immediately show up any large errors and is well worth while. The whole process is comparatively quick, taking rather less than 2 hours for calibration on any one frequency, and if any mistakes have been made in erecting the station they will be discovered before time is wasted in abortive tests with an aircraft.

As an illustration of what may happen, consider the effect of an accidental reversal of one pair of stator coil connections at the goniometer. The field due to this stator coil will be reversed so that bearings which are east of north will be west of north by a similar amount.

This is explained in Fig. 82. In (a) a bearing  $OX$  is shown due to the two goniometer fields  $OA$  and  $OB$ . In (b)  $OB$  is reversed, and it is clear that the bearing will be laterally reversed about  $OA$ , the angles  $AOX$  in each case being the same. This leads to results which are most puzzling until the cause is understood, the errors becoming approximately as shown in table below.

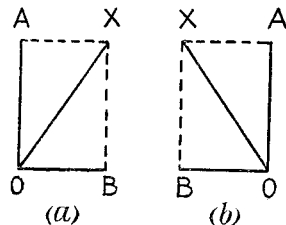

FIG. 82

| True Bearing | Goniometer  | Error        |
|--------------|-------------|--------------|
| $0^\circ$    | $0^\circ$   | $0^\circ$    |
| $20^\circ$   | $340^\circ$ | $-40^\circ$  |
| $45^\circ$   | $315^\circ$ | $-90^\circ$  |
| $90^\circ$   | $90^\circ$  | $0^\circ$    |
| $130^\circ$  | $230^\circ$ | $+100^\circ$ |
| $170^\circ$  | $190^\circ$ | $+20^\circ$  |
| $240^\circ$  | $120^\circ$ | $-120^\circ$ |

Not only are the errors absurdly large, but they appear to have no sort of connection with each other.

Whenever errors of this order appear on a preliminary calibration it may be safely assumed that a mistake has been made in connecting up the goniometer coils to the aerials.

### 2. CALIBRATION WITH AIRCRAFT

Final calibration of the station is made with assistance of an aircraft. It involves several hours' flying and requires close co-operation between the pilot, the wireless operator on the aircraft, and the operator at the D/F station. There are two methods of organizing the procedure.

(a) A number of points are selected covering an approximate circle round the D/F station at a radius of about 20 miles. It is

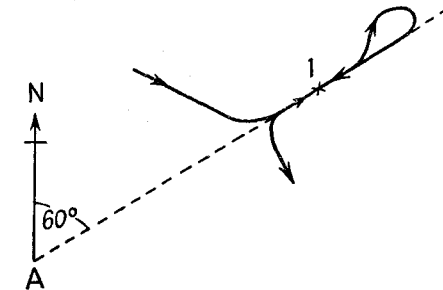

FIG. 83

important that these points should be easily identifiable and very definite. For example, a small town or village is too vague, but the local railway station, a church, or a main road junction would be quite suitable. The points are numbered 1, 2, 3, etc., in the order in which the aircraft will fly over them, and the correct true bearings are measured from the map. Provided the aircraft flies at a moderate height, say 2000 feet, polarization due to "aeroplane effect" is not likely at the range considered, but to increase precision it is usual for the aircraft to fly over each pin-point in at least two directions, and sometimes four directions are thought desirable. If two directions are taken, these would be towards and away from the D/F station respectively. (Fig. 83.)

In Fig. 83,  $A$  represents the D/F station and No. 1 point is taken as having a true bearing of  $60^\circ$ . The aircraft will fly over the point, first along a true bearing of  $60^\circ$  and then on the reciprocal of  $240^\circ$  before turning off for the next point.

NOTE. The pilot should be provided with the magnetic and magnetic reciprocal bearings for each point, as his own course will be set with reference to the aircraft compass.

If four directions are taken, the other two will also be reciprocals to each other and at  $90^\circ$  to the first two.

Wireless procedure is as follows. On taking off, communication is established with the D/F station by exchange of the usual signals.

On approaching the first point and about 2 minutes before reaching it, the aircraft operator sends the figure 1 to identify the point and a series of long dashes. The final long dash is started just before the aircraft passes over the point and ceases as it is directly overhead. The bearing taken is recorded at the D/F station. When the aircraft has turned on to the reciprocal course transmission recommences for the second observation, the whole process being repeated for each point.

The co-operation of the pilot is usually necessary to ensure accuracy in ceasing transmission at the right moment, because the

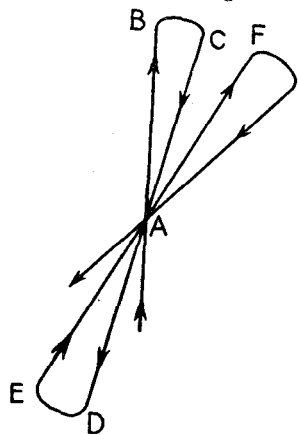

FIG. 84

A very fast aeroplane should not be used, because either the time for which a course is held will be too short for convenience or else the machine will fly out of sight on each leg. The next course is C to D, passing over the D/F station *en route*, then E to F and so on. The aircraft operator must transmit practically continuously except during turns, and the D/F operator takes bearings twice on each leg, once as the aircraft approaches and again as it flies away from the D/F station. At the same time visual bearings are taken on the aircraft with a hand compass, the results of all observations being afterwards tabulated. The aircraft must fly low, at a few hundred feet only, and the method is open to the objection that only very short ranges are used. It is, however, the quickest way of making a calibration with an aircraft, and when economy in flying time is important, it would almost certainly be adopted.

**Error Charts.** With modern D/F apparatus and a good site the residual errors will often be negligible and no correction chart need be used. If, however, noticeable errors appear during calibration, a larger number of check bearings would have to be taken. These

wireless operator in an aircraft cannot as a rule see outside well enough, quite apart from the possibility of his not recognizing the points concerned. A satisfactory method is for the pilot to hold his hand out about 15-20 seconds before passing over the point and drop it when the aircraft is directly overhead, the wireless operator acting accordingly.

(b) In this method the aircraft flies backwards and forwards over the D/F station on a number of agreed bearings, say every 10° or 15°.

Fig. 84 shows part of the route taken by the aircraft, A representing the D/F station. A to B is the first course and is of a length which represents about 2 minutes' flying, or about 4 to 5 miles.

are then plotted on squared paper and as smooth a curve as possible drawn through the plotted points. (Fig. 85.)

The final *correction* chart is prepared from this *error* chart by plotting the correction against scale reading. It would, of course, be quite wrong and confusing to plot corrections against the correct bearings.

Tabular form is found more convenient than graphical form for

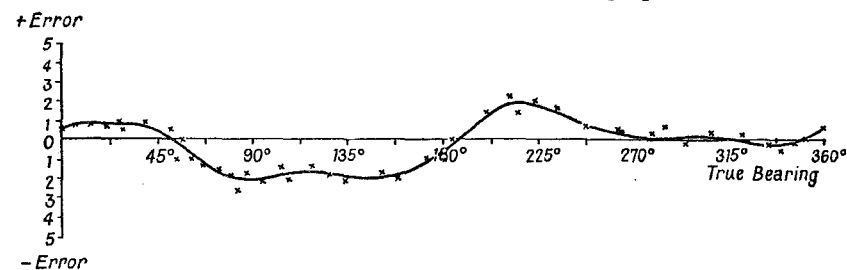

FIG. 85.

| Scale Reading | True Bearing | Scale Reading | True Bearing |
|---------------|--------------|---------------|--------------|
| 000           | 359          | 050           | 050          |
| 005           | 004          | 055           | 055          |
| 010           | 009          | 060           | 061          |
| 015           | 014          | 065           | 066          |
| 020           | 019          | 070           | 072          |
| 025           | 024          | 075           | 077          |
| 030           | 029          | 080           | 082          |
| 035           | 034          | 085           | 087          |
| 040           | 039          | 090           | 092          |
| 045           | 044½         |               |              |

FIG. 86

use on D/F stations, and the first 90° of the correction table derived from Fig. 85 is shown in Fig. 86.

In aircraft and ships the quadrantal errors are, of course, very much larger, maximum errors reaching 10° or more. Various methods have been devised for incorporating the correction chart with the D/F scale so that the application of the correction is either semi-automatic or in some cases fully automatic.

## CHAPTER VII

## AIRCRAFT D/F

It has been mentioned on page 1 that an alternative method of using D/F as a navigational aid is for the D/F apparatus to be installed on the mobile station, i.e. the ship or aircraft. Any fixed ground transmitter, the position of which is known, can then be used to obtain information for navigational purposes. The fact that the ship or aircraft need not transmit may be extremely important from a military aspect in time of war. In long overseas flights an aircraft may be temporarily out of range for ground D/F owing to the necessarily modest power of its own transmitter, but it would almost certainly be able to receive signals from a number of ground transmitting stations.

Thus, although ground D/F stations remain the basis of the system, the provision of D/F equipment in the aircraft is usually worth while and sometimes a necessity.

An aircraft is a poor site for a radio station, and for a D/F station it is even worse. The loop is close to masses of metal and its projection outside the aircraft spoils the streamline form. Only small loops can be used, and the amplification consequently required raises the noise level of the receiver.

The noise of the aircraft engines masks the minimum signal, and it is only the extraordinary selective powers of the human listening apparatus which makes it possible to locate the minimum at all. In rough weather it is almost impossible to keep the aircraft steady whilst a bearing is being taken. Nevertheless, in spite of these disadvantages, D/F in aircraft is a practical proposition, and most wireless operators in aircraft will be called upon to use D/F apparatus when the navigating officer requires it.

**Aircraft D/F System.** The simple rotating loop is the usual form of D/F in aircraft. Although there are no theoretical reasons against the use of B.T. or even Adcock aerials, the practical difficulties of applying these systems to aircraft are very serious. In biplanes, quite sizable B.T. loops can be arranged by winding them between the interplane struts, and this was done to some extent. The tendency now, however, is towards the monoplane as a universal type, and practically all modern aircraft have only one wing. B.T. aerials are therefore out of the question unless small crossed loops are adopted, but the single rotating loop has found more favour.

**Position of Loop.** The loop should be mounted in a central position, so that its spindle passes through the fore-and-aft line of the aircraft. This is not absolutely essential, but it tends to produce a more symmetrical quadrantal error, which is correspondingly

easier to correct. The position of the loop relative to the nose and tail of the aircraft is dictated mainly with reference to the position of the D/F receiver and the method of operating the loop. In most large aircraft the W/T cabin is situated behind the pilot's cockpit, i.e. at or very close to the deepest part of the fuselage or hull, so that the loop can often be conveniently mounted on the highest point of the aircraft structure, and operated directly by means of a suitable hand-wheel. In some cases the loop is made retractable, so that it can be withdrawn inside the aircraft when not in use.

Fig. 87 shows a typical position for the loop.

Direct operation of the loop is not always possible. The modern aeroplane contains such a quantity of supplementary equipment that even a very large machine appears to have every available

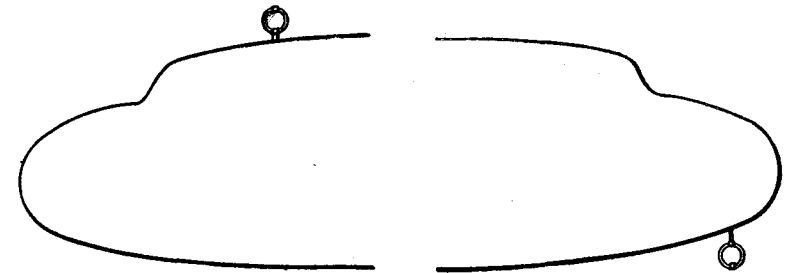

FIG. 87

FIG. 88

corner filled up, and it may be necessary to use remote control for the loop aerial.

In this case, the loop can theoretically be mounted anywhere, but the principle of placing it on the fore-and-aft line holds good, and of course it is desirable to keep the remote control cable run as short as possible. The design of remote control gear for D/F loops is important because it is most essential that there should be no backlash or stiffness at any point. These faults not only give rise to considerable annoyance when using the loop but may cause errors.

Fig. 88 shows another position for a remote-controlled loop, which has been used to some extent in cases where no convenient point is available on the roof. It is not a good position. The cable run is much longer than that required for roof mounting, and the low situation of the loop makes calibration on the ground unreliable. Experience has also shown that damage to the loop is extremely likely when the aircraft is in the hangar.

**Types of Aircraft Loop.** These can be classified into three divisions—

1. Unscreened loops.
2. Screened loops.
3. Totally enclosed loops.

Fig. 89 shows a two-turn unscreened loop for use on medium frequencies. The turns are steel tubing and have a diameter of  $16\frac{1}{2}$  in. The chief advantages of this type of loop are its low weight and

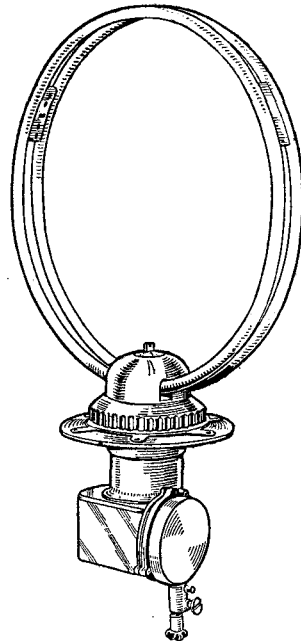

FIG. 89

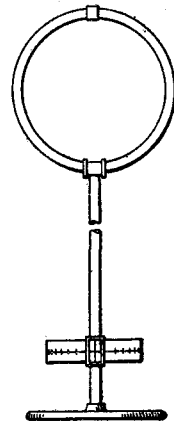

FIG. 90

comparatively small air resistance, which is only about 10 lb. at an air speed of 300 m.p.h. with the loop set at  $090^\circ$  to the line of flight.

Fig. 90 shows a type of screened loop for aircraft. The steel tube

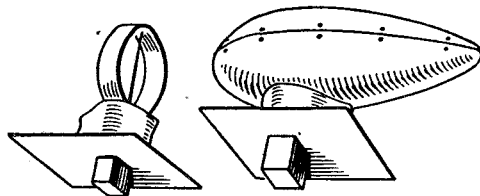

FIG. 91

is broken at the top by insulation (see page 38) and contains eighteen turns. Its diameter is approximately 14 in. This loop is more robust than the type previously described, but its weight and air resistance are much greater.

Fig. 91 shows a type of totally enclosed loop, which is mounted inside a streamlined housing.

The housing, of course, remains stationary, whilst the loop rotates. Very small loops are employed with this method, some being only three or four inches in diameter, and having a proportionately greater number of turns. The advantages of the totally enclosed loop are that the air resistance is very much smaller, and that the

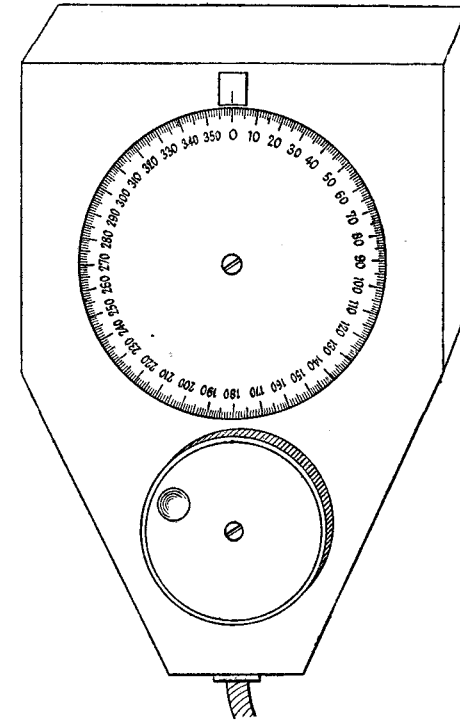

FIG. 92

loop itself does not have to be weatherproof. The modern tendency in aircraft D/F is towards totally enclosed loops.

**Scales for Remote Controlled Loops.** When remote control is used, the D/F scale is associated with the control end of the cable, and takes various forms.

Fig. 92 shows one type of D/F scale for use with a remote controlled loop. The scale moves and the pointer is fixed, but anti-clockwise engraving (see page 13) is not necessary, because the gearing can be arranged to reverse the scale movement.

In some cases the scale is calibrated from  $0^\circ$  to  $180^\circ$  on each half, one half being coloured red and the other green. Provided bearings are sensed, this gives a direct indication of the bearing relative to the nose of the aircraft, i.e. whether it is on the port (red) or on the starboard (green) side. The scale reading must of course be  $000^\circ$

when the plane of the loop is athwartships—at  $090^\circ$  to the line of flight.

Corrections for quadrantal error would be obtained from a correction table.

Fig. 93 shows another type of remote control and scale. The scale is fixed and the radial arm rotates, a complete  $360^\circ$  rotation corresponding to  $32\frac{1}{2}$  turns of the operating handle. The radial

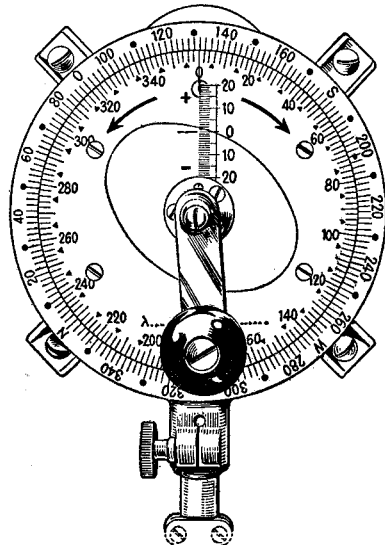

FIG. 93

arm has a scale marked from  $+20^\circ$  to  $-20^\circ$ , and a curve drawn on the stationary dial intersects the scale. The point of intersection gives the correction for quadrantal error at that position. The outer scale is engraved on a movable verge ring, and its purpose will be described shortly.

**Taking Bearings in Aircraft.** Since an aircraft is not fixed, the fore-and-aft line of the machine must be used as a datum line for D/F bearings instead of True North. This, of course, is the reason for the loop being set so that the scale reading is  $000^\circ$  when the loop is at  $090^\circ$  to the fore-and-aft line. The direction of a ground transmitter from the aircraft must therefore be found by combining the D/F reading and the compass reading.

In Fig. 94, if the aeroplane is flying on a magnetic (compass) course of  $035^\circ$  and the apparent bearing of a distant ground transmitter X is  $110^\circ$ , the actual bearing of the transmitter from the aircraft is  $110^\circ + 35^\circ = 145^\circ$  Magnetic. If a True Bearing is required, the local Magnetic Variation must be allowed for.

The purpose of the movable outer verge ring of Fig. 93 will now

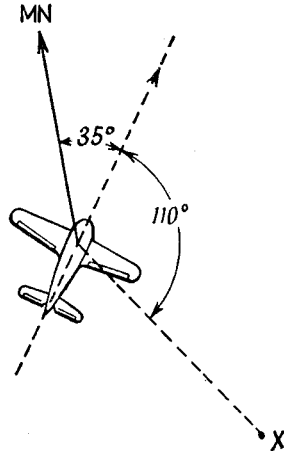

FIG. 94

be clear. If it is set so that the corrected compass reading coincides with  $000^\circ$  on the D/F scale, D/F bearings from Magnetic North can be read directly by consulting the outer scale. In Fig. 93 the aircraft would be flying on a magnetic course of  $132^\circ$ .

It is obviously essential that the aircraft should hold a steady course whilst a D/F bearing is being taken, and it should also be in level flight, neither gaining nor losing height. If the nose is slightly up or down, or one wing is a little low, the spindle of the loop aerial will not be vertical and a small error may arise. In rough weather the difficulties are increased, but there is a better chance of effective use of the D/F apparatus if an automatic pilot is in operation. The response of an automatic pilot to any positional disturbance of the aircraft is so rapid that a comparatively even keel is maintained.

The compass should be read as nearly simultaneously with the D/F bearing as possible. Reading the compass is not normally the province of the wireless operator, and a short time lag is unavoidable if bearings have to be passed to the pilot in writing.

The use of an efficient intercommunication telephone system overcomes this difficulty, and in large aircraft the wireless operator and the navigator are often close to one another and can co-operate in the matter, the navigator having his own compass as distinct from the pilot's compass.

It is naturally most important that no misunderstanding should occur in the passing of D/F information from the wireless operator to the pilot or navigator as the case may be, whether the bearings are obtained from a ground D/F station or by means of the aircraft D/F. Even in aeroplanes designated as "quiet," conversation can be conducted only by means of shouts, and remarks are more often than not repeated in even louder shouts before they are understood. It is therefore the practice for the wireless operator to write down D/F information on a slip of paper and pass this to the pilot or navigator. When this is done, it is essential that both the D/F bearing *and* the station should be given. In most cases the pilot will know the station, but the practice of writing down the bearing only will inevitably lead to confusion and danger sooner or later. The author was personally connected with an incident in which the pilot thought the bearing was from one station, whereas it was actually from another, thus causing what was apparently an enormous error. His indignant protests on landing and the resulting inquiries explained the error, but of course it should never have occurred.

**Calibration of Aircraft D/F.** The process of compiling a correction table for quadrantal error consists of two stages—calibration on the ground, followed by a check calibration in the air.

In the case of land machines, the ground calibration is usually carried out with the aircraft on a compass base. This is a flat circle of concrete marked at the cardinal points. The compass base is intended for compass calibration, and there is no particular reason

for using it when calibrating the D/F loop, except convenience. The concrete circle is usually well away from buildings and provides a suitable place for manoeuvring the aircraft by hand.

The aircraft should be in the position of level flight, so that the loop aerial spindle is vertical. The tail should therefore be raised on a trestle to the required height. As the aircraft has to be moved round a few degrees at a time, this is a rather laborious process. It is greatly facilitated if the compass base takes the form of a turntable, but such an arrangement is not common. With most aircraft, however, the errors will be very small, even if the tail is not raised, and with the recently introduced tricycle undercart the position of the aircraft on the ground is practically that of level flight.

The next step is to select a distant transmitter. The exact position of the transmitting aerial must be known, and its correct bearing from the compass base worked out. A broadcasting station is, of course, ideal for the purpose.

The aircraft is then placed so that the fore-and-aft line is on this bearing with the nose of the machine pointing towards the transmitter. The corrected reading of the aircraft compass should then correspond to the magnetic bearing of the transmitter from the compass base. If the aircraft compass has recently been "swung," this is a sufficient check on the position of the aircraft, but it is sometimes considered desirable to make an additional check by means of a tripod compass placed a short distance from the aircraft. Plumb lines are suspended from the nose and tail of the aircraft to mark the fore-and-aft line, and are sighted on the tripod compass.

A bearing is then taken on the distant transmitter and should, of course, be 000°. The aircraft is now moved round anti-clockwise about 10° and the corrected compass reading observed. The new D/F bearing is then taken. The results can be recorded as shown in the specimen table on page 71.

On completion of this process through the whole circle of 360°, the information obtained enables a provisional error curve to be prepared.

Fig. 95 (a) shows the *error* curve resulting from the foregoing table, and (b) is the corresponding *correction* curve. Note that the correction curve is formed by plotting the errors with signs changed against the scale reading (see page 63).

An air test follows by flying over a fixed point on a steady course at a height of, say, 2000 feet, and again recording the compass readings and D/F bearings every 10°, using the same transmitter. It is convenient if the compass base or other point used for ground calibration can also be used as the fixed point for air calibration, so that a direct comparison can be made between ground and air results. If a close agreement is found on the first few directions, it is sufficient to check the remainder every 30° or so.

| Magnetic Brg. of Xmg. Aerial from Compass Base | Corrected Compass Reading | Correct D/F Brg. from a/c | D/F Scale Reading | Error |
|--|---------------------------|---------------------------|-------------------|-------|
| 046 (e.g.)                                     | 046                       | 000                       | 000               | 0     |
| 046  | 036                       | 010                       | 006               | - 4   |
| 046  | 026                       | 020                       | 012               | - 8   |
| 046  | 016                       | 030                       | 020               | - 10  |
| 046  | 006                       | 040                       | 029               | - 11  |
| 046  | 356                       | 050                       | 039               | - 11  |
| 046  | 346                       | 060                       | 050               | - 10  |
| 046  | 336                       | 070                       | 063               | - 7   |
| 046  | 326                       | 080                       | 075               | - 5   |
| 046  | 316                       | 090                       | 088               | - 2   |
| 046  | 306                       | 100                       | 102               | + 2   |
| 046  | 296                       | 110                       | 115               | + 5   |
| 046  | 286                       | 120                       | 129               | + 9   |
| 046  | 276                       | 130                       | 140               | + 10  |
| 046  | 266                       | 140                       | 150½              | + 10½ |
| 046  | 256                       | 150                       | 160               | + 10  |
| 046  | 246                       | 160                       | 167               | + 7   |
| 046  | 236                       | 170                       | 174               | + 4   |
| 046  | 226                       | 180                       | 182               | + 2   |
| 046  | 216                       | 190                       | 189               | - 1   |
| 046  | 206                       | 200                       | 195               | - 5   |
| 046  | 196                       | 210                       | 201               | - 9   |
| 046  | 186                       | 220                       | 209½              | - 10½ |
| 046  | 176                       | 230                       | 219½              | - 10½ |
| 046  | 166                       | 240                       | 231               | - 9   |
| 046  | 156                       | 250                       | 243               | - 7   |
| 046  | 146                       | 260                       | 255               | - 5   |
| 046  | 136                       | 270                       | 268               | - 2   |
| 046  | 126                       | 280                       | 282               | + 2   |
| 046  | 116                       | 290                       | 295½              | + 5½  |
| 046  | 106                       | 300                       | 307½              | + 7½  |
| 046  | 096                       | 310                       | 319               | + 9   |
| 046  | 086                       | 320                       | 330               | + 10  |
| 046  | 076                       | 330                       | 340               | + 10  |
| 046  | 066                       | 340                       | 348               | + 8   |
| 046  | 056                       | 350                       | 355               | + 5   |
| 046  | 046                       | 000                       | 000               | 0     |

The final correction chart may be prepared in the form of a table similar to that shown on page 63.

In the case of a remote control scale of the type shown in Fig. 93, the correction curve is drawn in as indicated, and the radial scale + 20° to - 20° gives a direct reading of the correction to be applied.

**Reduction of Quadrantal Error.** The maximum quadrantal error depends to a great extent upon the position of the loop on the aircraft, and it would be possible to find a position at which the quadrantal error would be comparatively small. The selection of a position for the loop, however, is rarely a matter for the wireless operator, and in any case, so many other factors enter into it that the loop is seldom sited with a view to reducing quadrantal error.



It will be seen from Fig. 95 (a) that the error is negative on the first quadrant ( $0^{\circ}$ - $90^{\circ}$ ), positive on the second quadrant, and so on. This shows that all bearings are being pulled towards the fore-and-aft line of the aircraft, and is typical of results when the loop is

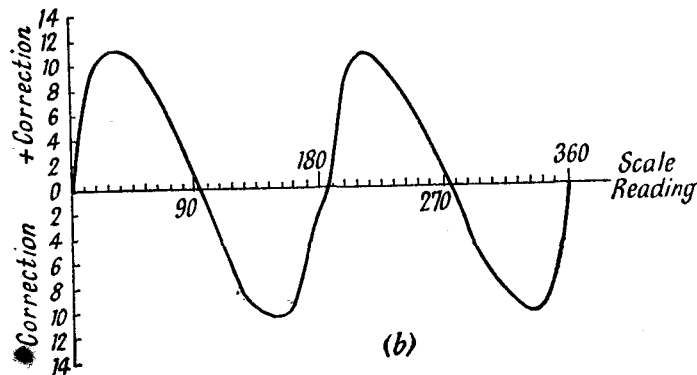
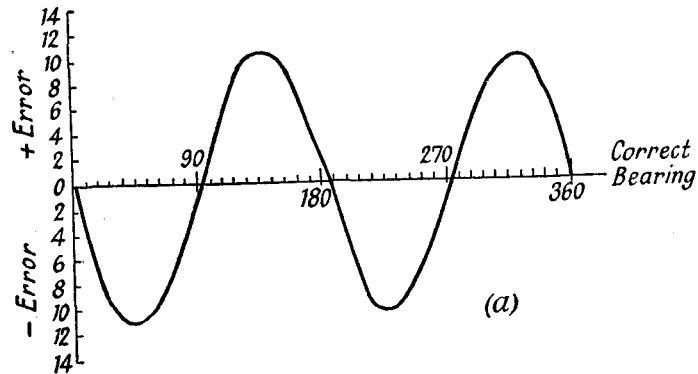

FIG. 95

mounted on the fuselage or hull well clear of the wings. If the loop is mounted on or very close to the wings, the bearings may be pulled towards the athwartships line, thus causing a positive error in the first quadrant.

In the more usual case of negative error in the first quadrant, the quadrantal error can be greatly reduced by the use of a fixed correcting loop placed on or parallel to the fore-and-aft line. This has

been done with totally enclosed loops, in which case the correcting loop can be conveniently mounted inside the streamline casing.

Fig. 96 shows the position of the correcting loop. It is a closed single turn loop and the result of its re-radiation on the rotating frame is to reduce the effect of re-radiation from the fuselage or hull of the aircraft, thus opposing the tendency for bearings to be pulled towards the fore-and-aft line. The circuit of the correcting loop is completed through a small tapped inductance  $L$  in Fig. 96. The position of the tapping point is adjusted by trial to give the maximum reduction of quadrantal error. It should be noted that

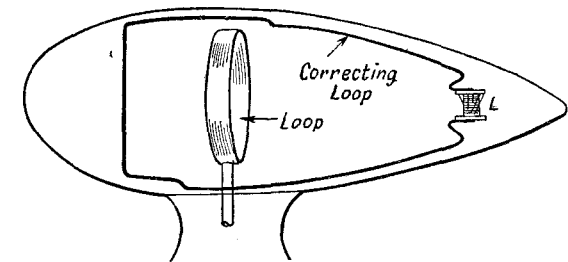

FIG. 96

a fore-and-aft correcting loop is quite useless if the error is positive in the first quadrant.

In this case, the correcting loop is either not fitted or is left on open circuit by the removal of the tuning coil  $L$ .

**Sensing Bearings in Aircraft D/F.** A heart-shaped polar diagram can be obtained by switching in a suitable open aerial, and the theory of the scheme has been explained in Chapter IV.

Either the fixed or trailing aerial can be employed for heart-shape reception, but the use of the fixed aerial is more usual.

The action of swinging a loop aerial through  $180^{\circ}$  is clumsy compared with a similar step applied to the search coil of a goniometer. It is also very slow if the loop aerial is operated by remote control.

One way of accelerating the sensing process is to use electrical "swinging" by providing a switch which reverses the frame aerial connections. This is equivalent to rotating it through  $180^{\circ}$ , but, of course, far quicker.

The principle of the circuit is shown in Fig. 97. The two positions of the sensing switch must be marked in some way so that the heart-shape indications can be interpreted correctly. For example, "B" and "R" could be used as in Fig. 97, these letters meaning "Bearing" and "Reciprocal."

The method of sensing the bearing will be seen from the following illustrations.

1. USING DIRECTLY-OPERATED LOOP

An additional "Sense" scale is fitted displaced 90° from the D/F scale. (Fig. 98.)

Now, suppose a bearing is being taken on a transmitter which

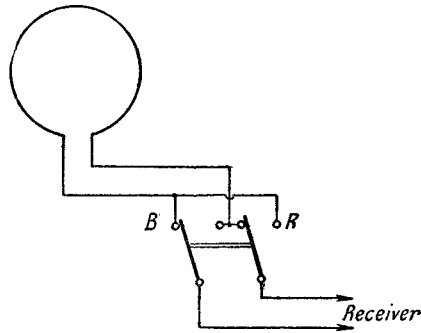

FIG. 97

lies straight ahead of the aircraft, i.e. on a sensed bearing of 000°. Two cases may arise. Either the D/F minimum at 000° or the one

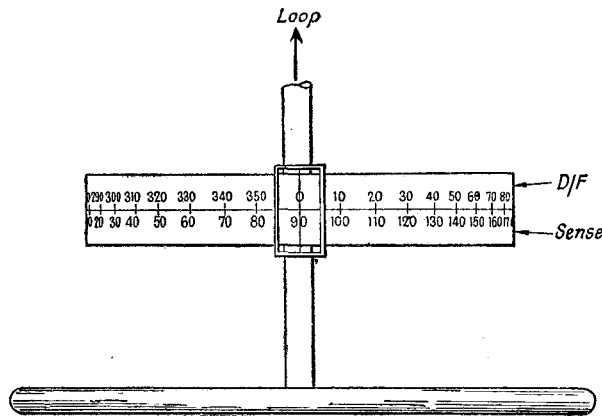

FIG. 98

at 180° may be taken in the first place. The procedure for sensing is as follows—

- (a) Determine one minimum.
- (b) Turn loop to give same reading on the sense scale, i.e. rotate it through 90°.
- (c) Compare signal strengths in the two positions of the sense switch. If "B" is a minimum, the bearing is correct. If "R" is a minimum, the correct bearing is the reciprocal of the sense scale

reading. Step (c) will give correct sense whichever minimum is first taken, as will now be shown.

In Fig. 99 the inner circle represents the D/F scale and the outer circle the "Sense" scale. In (a) the minimum at 000° has been taken on D/F. In (b) the sense scale has been turned to read 000°,

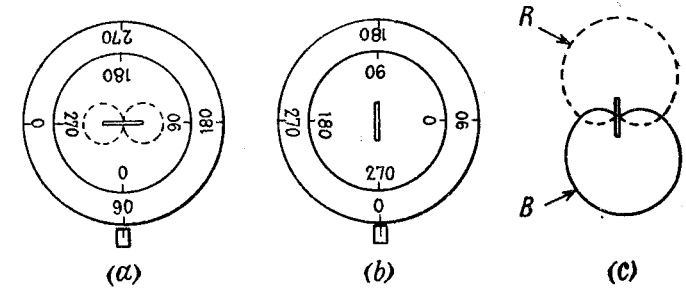

FIG. 99

thus rotating the loop through 90°. In (c) the two heart-shape diagrams given by the sense switch are shown, and it is clear that, if the transmitter is at 000°, "B" will give a minimum. A sensed bearing of 000° is, therefore, indicated.

In Fig. 100 (a) the minimum at 180° has been taken on D/F. In (b) the loop has been turned 90° so that the sense scale reads

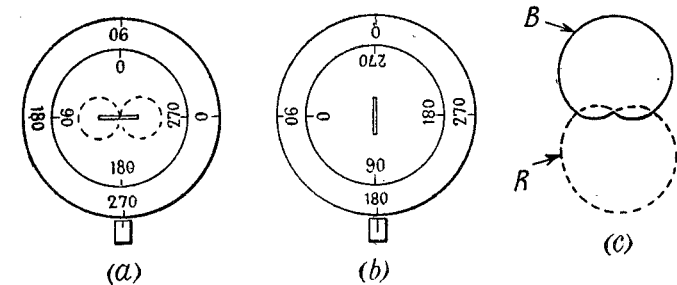

FIG. 100

180°. In (c) the two heart-shape curves are shown. Since the transmitter is actually at 000° it is clear that "R" will give a minimum, thus indicating that the true bearing is the reciprocal of 180°, i.e. 000°.

2. USING REMOTE CONTROLLED LOOP

The only difference here is that an additional sense scale is not necessary. A sense pointer must be fitted at 90° to the D/F pointer. To sense a bearing, the minimum is first determined on D/F as before, and the sense pointer then placed on this minimum.

Manipulation of the sense switch will then indicate whether that bearing or its reciprocal is correct.

In some aircraft D/F apparatus no provision is made for direct sensing of the bearing, but in these cases sense can be determined in some other way.

An example of this scheme will be described later in this chapter.

**Homing.** The term "Homing" means the use of D/F to enable an aircraft to fly towards a particular radio station, which would normally be situated at or very close to the aerodrome of destination. If the radio station is a D/F station, the method consists merely of giving the aircraft a series of Magnetic Reciprocal Bearings until it flies over the D/F station. If the radio station is an all-round transmitter, the D/F apparatus must clearly be on the aircraft, and when such apparatus has some form of automatic indication it is commonly called a Radio-compass.

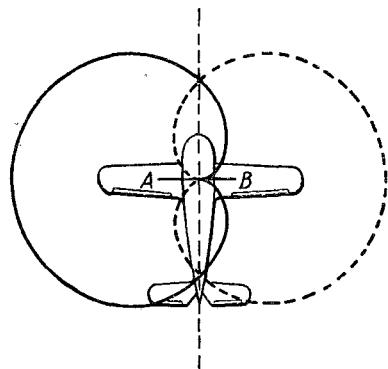

FIG. 101

If the loop aerial on an aircraft is fixed at  $090^\circ$ , i.e. in the athwartships position, there will be zero signal from a transmitter which lies straight ahead. Any deviation from this course will result in an increased signal, but

this indication that the aircraft is off course is practically useless unless accompanied by an indication as to which side of the correct course the deviation has occurred. It is this necessity for showing the "Sense"—so to speak—of the deviation which makes homing equipment much more complex than might otherwise be expected.

The side on which the correct course lies can be shown by means of special devices which may exist wholly at the ground transmitter, wholly in the aircraft, or partly in each. For the present purpose, only aircraft apparatus will be considered. That is to say, the ground transmitter is assumed to be non-directional (e.g. a broadcasting station) and the course indication is given entirely by means of the aircraft D/F and homing instruments.

The most commonly used principle in modern homing devices is that of "switched cardioids."

In Fig. 101,  $AB$  represents a loop aerial at  $90^\circ$  to the fore-and-aft line of the aircraft. If an open aerial is also provided to give heart-shape reception, two such heart-shapes will be associated with the frame according to the frame connections, and a reversing switch will enable either heart-shape to be selected. (Compare Figs. 99 and 100.)

Fig. 102 shows the effects produced when the aircraft is on course

and off course. (a) is the on-course condition, and it is at once clear by symmetry that the same strength of signal ( $OX$ ) will be received on each heart-shape. Manipulation of the change-over switch will therefore cause no variation of signal strength.

In (b) the aircraft is off course to the left. The left-hand heart-shape will give a signal strength represented by  $OX$ , and the right-hand heart-shape will give  $OY$ , which is much louder.

In (c) the aircraft is off course to the right, and inspection will

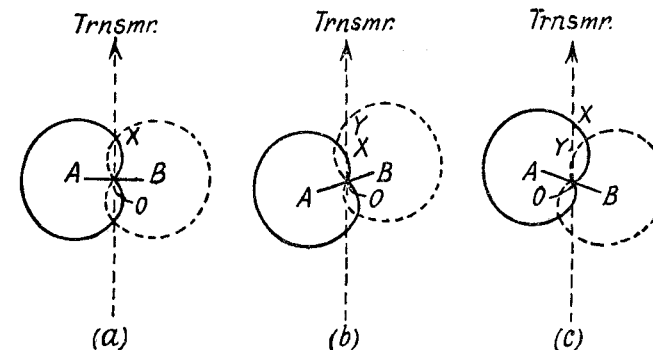

FIG. 102

show that the left-hand heart-shape will now give the louder signal ( $OX$ ).

From these facts it is clear that a means does exist of differentiating between the left- and right-hand sides of the correct course. It remains to decide the method of indication.

1. The most direct scheme is to mark the reversing switch with steering instructions.

An example of such a switch is shown in Fig. 103. The "L" and "R" mean "Left" and "Right" and the instructions mean that, if for example the "R" position gives the louder signal, the aircraft must be steered to the right to get back on course. When on course, there is no difference in the signal strength for either position of the switch. Examining Fig. 102, it will be seen that the switch must be wired so that the "L" position corresponds to the left-hand heart-shape.

This method is essentially one for the wireless operator, and is open to objections because the pilot of the aircraft has no direct indication.

## 2. VISUAL HOMING

In this method a direct indication is given to the pilot. This takes the form of a centre-zero, moving-coil microammeter, the scale of which is marked as shown in Fig. 104.

The central position of the needle indicates on course, and a

deflection to the right (R) or left (L) shows that the aircraft must be steered right or left correspondingly in order to correct the deviation from course. The idea is very simple, but considerable complication is involved to bring about this result.

The reversing switch of Fig. 103 is replaced by a mechanically

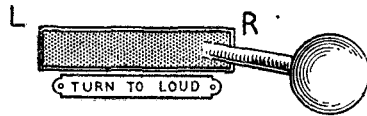

FIG. 103

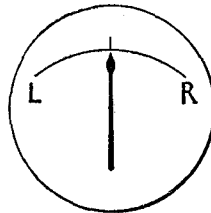

FIG. 104

driven rotary switch, which operates about ten to twelve times per second. The output from the receiver is fed to the moving-coil instrument through a pair of rectifiers selected in turn by a second

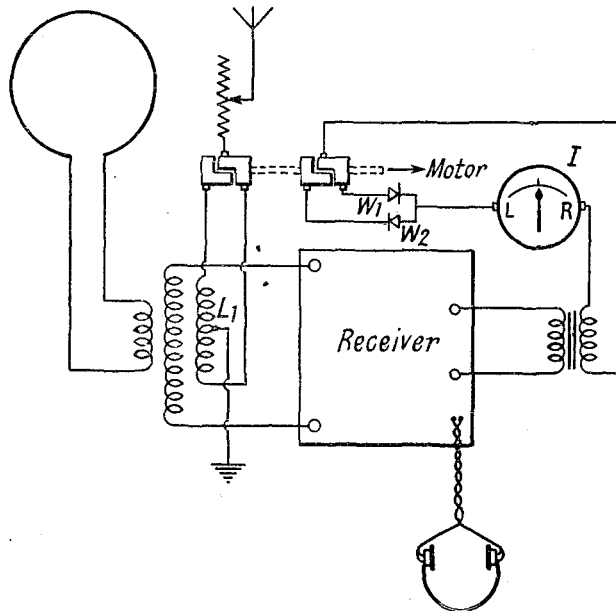

FIG. 105

rotary switch running synchronously with the first. Both switches are on the same shaft, and are driven by a small electric motor supplied from the aircraft's main battery.

The circuit arrangements are shown in Fig. 105. The vertical aerial current is fed through each half of the coupling coil  $L_1$  in

turn, thus giving the reversing or "switched cardioid" action. The rectifiers  $W_1$  and  $W_2$  allow current to pass through the instrument  $I$ , first in one direction and then in the other, according to the position of the rotary switch, and as this switch is synchronized with the open-aerial reversing switch, the moving-coil receives an impulse in one direction on the left-hand heart-shape and in the reverse direction on the right-hand heart-shape.

If the aircraft is on course, these impulses will be equal (Fig.

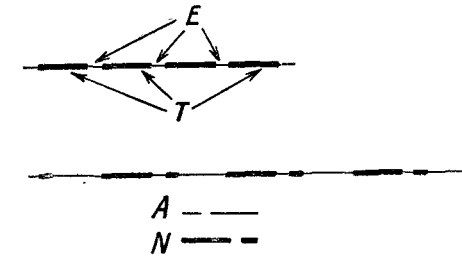

FIG. 106

102a), and the instrument is sufficiently damped for the needle to remain stationary.

In the case of an off-course condition to the left (Fig. 102b), the right-hand heart-shape will give the stronger impulse, and the needle will move over to the right.

The sensitivity of this type of visual homing indicator can be very good, and with well-designed apparatus a deviation from course of only  $2^\circ$  will give a visible movement on the instrument.

Ordinary reception on headphones is, of course, also provided so that the receiver can be tuned and stations identified.

### 3. AURAL HOMING

In this scheme, the on-course indication is a continuous signal of unvarying strength, assuming that the distant transmitter radiates continuously.

Off-course indications are given by two Morse letters. One of these becomes audible when the aircraft is off course to the left, and the other one when off course to the right. The two letters must interlock, i.e. the spaces of one must correspond to the dots and dashes of the other. E and T or A and N are the most commonly used pairs, and Fig. 106 shows how the interlocking occurs.

The method of introducing the Morse letters is to replace the open-aerial reversing switch of Fig. 105 by a pair of rotating contacts cut to give the interlocked letters.

This is shown in the circuit diagram of Fig. 107. When on course, the dot (E) and the dash (T) will be heard at the same strength (OX of Fig. 102a), and since they interlock, a continuous signal of constant strength is the result.

If off course to the left, the volume of one will increase and that of the other decrease, as in Fig. 102*b*.

It is usual to arrange that E or A is heard on the left of the course, and T or N on the right. E or A therefore means "Turn Right" and T or N means "Turn Left."

The sensitivity of this method can be as good as that of the visual

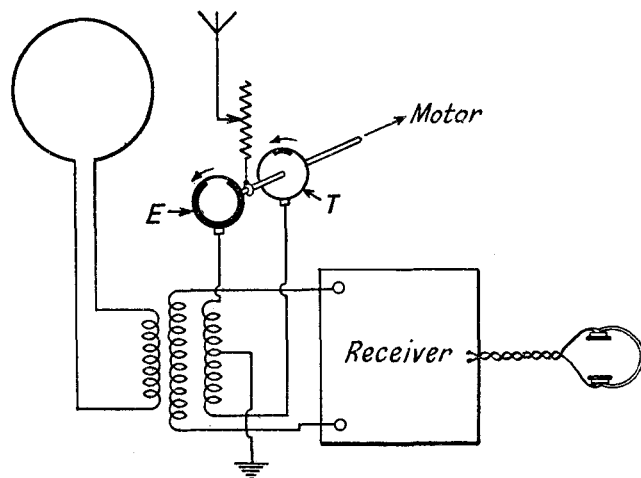

FIG. 107

indicator, but it has a rather serious disadvantage in the necessity for listening continuously to a signal. The pilot has to wear headphones, which mask the sound of the aircraft engines, and impede the hearing of any remarks by his captain, co-pilot, or navigator. In addition, the continuous signal is apt to be irritating, especially to any one engaged in the complex and responsible task of flying an aircraft in bad weather and poor visibility.

**Interpretation of Homing Indications.** A homing device can be used as a guide in flying either towards or away from a ground transmitter, and occasions may arise when there is an element of uncertainty as to whether the transmitter is ahead or astern.

The position is summarized in Fig. 108. In (a) the aircraft is off course to the left. Calling the radius of the left-hand heart-shape  $OX$  and the radius of the right-hand heart-shape  $OY$ , an inspection of the diagram will show that if the transmitter is ahead,  $OY$  is greater than  $OX$ . This gives a needle deflection to the right on visual and the Morse E on aural.

If, however, the transmitter is astern,  $OX_1$  is greater than  $OY_1$ , thus giving a needle deflection to the left or the Morse T.

In (b) the aircraft is off course to the right, and examination will show that all these indications are now reversed.

It might at first sight appear to be a very confusing and complicated business to interpret indications which seem capable of meaning anything, but actually it is quite simple, and an example will demonstrate the method.

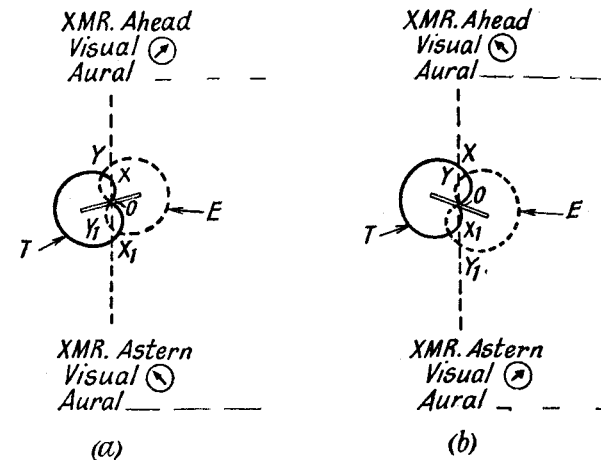

FIG. 108

#### EXAMPLE 1. Aircraft On Course.

Continuous signal on aural.

Visual needle central.

To determine whether transmitter is ahead or astern—

Turn aircraft slightly—say to LEFT.

|         |   |                       |
|---------|---|-----------------------|
| If this | { gives E on aural<br>moves needle to right } | Transmitter is AHEAD  |
| If this | { gives T on aural<br>moves needle to left }  | Transmitter is ASTERN |

#### EXAMPLE 2. Aircraft Off Course.

E on aural.

Needle to right on visual.

If turning aircraft to RIGHT—

|  |                      |
|--|----------------------|
| { Merges E into the T<br>Brings needle back towards centre } | Transmitter is AHEAD |
|--|----------------------|

If turning aircraft to LEFT—

|  |                       |
|--|-----------------------|
| { Increases volume of E<br>Moves needle further to right } | Transmitter is ASTERN |
|--|-----------------------|

As regards the visual indication, further generalization is possible as follows—

With transmitter AHEAD, follow the needle to keep on course.

With transmitter ASTERN, steer opposite to the needle to keep on course.

If off course, following the needle will reduce the deflection

when the transmitter is AHEAD, but increase it if the transmitter is ASTERN.

Regarding the central position of the needle as the fore-and-aft line of the aircraft, the needle will always move towards that side of the fore-and-aft line on which the transmitter lies, whether it is ahead or astern.

When in use for homing, the loop aerial is placed at  $90^\circ$  to the fore-and-aft line, i.e. at a scale reading of  $000^\circ$  (or at some pre-

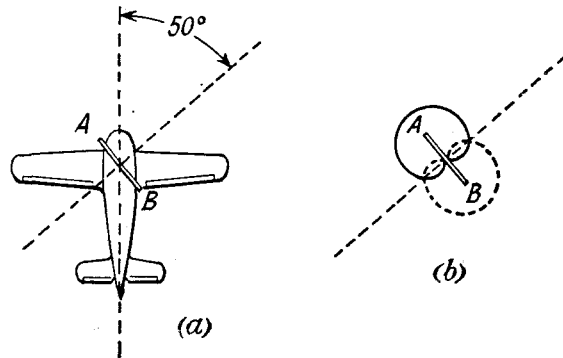

FIG. 109

determined angle if a correction for drift due to cross-wind is applied). This is the position at which the indications shown in Fig. 108 and described in the context hold good. It is clear, however, that if the loop is set to a scale reading of  $180^\circ$ , the heart-shape diagrams will be laterally reversed, and the indications normal for a transmitter ahead will then be given by a transmitter which is astern, all the indications shown in Fig. 108 being reversed.

The practical use of this action is that if a pilot prefers to have the same indications when flying *away* from a transmitter, they can be obtained if the wireless operator reverses the loop.

Although, when thoroughly understood, the course indications are quite easy to interpret, the possibility of confusion is very real. In the event of doubt, the wireless operator should be able to advise the pilot and explain the particular circumstances, and any wireless operator in an aircraft fitted with full D/F homing and apparatus would be well advised to master the points just discussed with more than ordinary care. He should take every opportunity of observing and checking homing indications until he has complete confidence in his understanding of them.

**Use of Homing Device for Sensing D/F Bearings.** D/F apparatus in aircraft takes various forms, which can be classified broadly as follows—

1. Visual homing only (radio-compass), the loop being fixed

permanently at  $90^\circ$  to the fore-and-aft line. This scheme is suitable for small private aircraft.

2. D/F only, with sensing facilities. This assumes the services of a wireless operator.

3. Full D/F facilities, plus visual homing, and in some cases aural indication as well. This scheme is suitable for large commercial aircraft.

It has been mentioned that when full D/F and homing is provided,

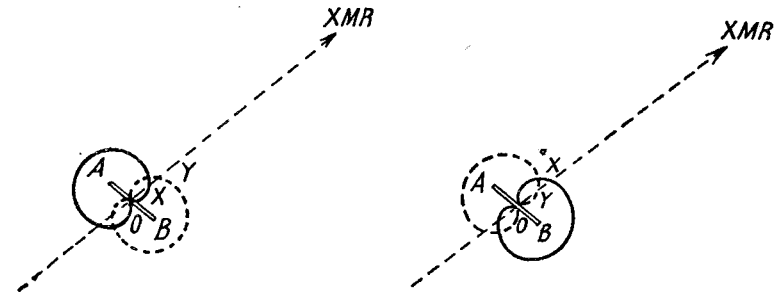

FIG. 110

FIG. 111

there is sometimes no sense position for use when taking bearings. In this case, the homing device is used for sensing the bearings.

It will be clear that the heart-shape curves of Fig. 102 will hold good for any position of the loop.

In Fig. 109 (a) assume that the operator is taking a bearing on a distant ground transmitter, the direction of which forms an angle of  $50^\circ$  (or its reciprocal) with the fore-and-aft line of the aircraft. A minimum will be obtained when the loop  $AB$  is in the position shown, and the D/F scale reading will be  $050^\circ$ . In order to sense the bearing, the controls are turned to "Homing," and the situation becomes as shown in (b), which will clearly give an on-course indication, both visually and aurally. A small rotation of the loop either way will be exactly equivalent to the off-course conditions shown in Fig. 108, and the results can be interpreted as follows.

1. If movement of the loop shows that the transmitter is AHEAD, the bearing is correct.
2. If movement of the loop shows that the transmitter is ASTERN, the bearing is the reciprocal of the scale reading.

The process of sensing is, therefore, very simple and can be completed in a matter of seconds. In order to make it quite clear, the case of Fig. 109 will now be analysed. Assume for the purpose of the example that the bearing of the distant transmitter is actually  $050^\circ$ .

CASE 1. When the  $050^\circ$  minimum is taken.

Fig. 110 shows the result of switching to "Homing" and turning the loop aerial slightly to the left (decreasing scale reading).  $OY$  is

greater than  $OX$ , so that the AHEAD indications of Fig. 108 (a) will be given. This confirms that the correct bearing is  $050^\circ$ .

CASE 2. When the  $230^\circ$  minimum is taken.

Fig. 111 shows the result of switching to "Homing" and turning the loop aerial slightly to the left (decreasing scale reading).  $OX$  is now greater than  $OY$ , so that the ASTERN indications of Fig. 108 (a) will be given. This shows that the correct bearing is the reciprocal of  $230^\circ$ , i.e.  $050^\circ$ . Note in Fig. 111 that the reversal of the loop has also reversed the position of the heart-shape diagrams, thus giving the ASTERN effect.

ABNORMAL polarization, 42  
 Accuracy of D/F, 5  
 Adcock aerials, 45  
 Aircraft, DF, 64  
 Area of doubt, 34

BALANCING condenser, 37  
 Beacon, rotating, 15  
 Bearings, 2  
 Bellini-Tosi, 19

CALIBRATION, 60, 69  
 Cardioid, 26  
 Classification of bearings, 33  
 Coast beacons, 2  
 ——— refraction, 50  
 Correcting loop, 73  
 Cosine diagram, 10  
 Coupling error, 22

D/F circuits, 53  
 Differential condenser, 37  
 Direct pick-up, 39  
 Displacement error, 39  
 D.R. navigation, 1

ELECTRIC wave, 6  
 Error chart, 62  
 Errors in D/F, 36, 52

FADING, 49  
 Fix by single D/F station, 35  
 Fixing, 4, 33  
 Frame aerial, 10  
 ——— dimensions, 14

GONIOMETER, 19

HEART-SHAPE diagram, 27  
 Homing, 76  
 ——— aural, 79  
 ——— visual, 77

INDIRECT ray, 47

LAYERS E and F, 46  
 Loop aerial, 10, 66  
 ———, remote control, 65

MAGNETIC bearings, 3

## INDEX

Magnetic north, 3  
 ——— reciprocal bearings, 3  
 Magnetic variation, 3  
 Matching B.T. aerials, 21  
 Maximum of figure-8, 11  
 Minimum of figure-8, 12

NIGHT effect, 42  
 ——— effect, symptoms, 48

OCTANTAL error, 22  
 Open aerial, 9  
 Orientation of masts, 57

PHASING for sense, 28  
 Polar co-ordinates, 8  
 ——— diagram, 7  
 Polarization, 42  
 Process of D/F, 30

QUADRANTAL error, 39, 71  
 Quadrature compensation, 40

RADIOGONIOMETER, 19  
 Resistance phasing, 29  
 Rotating beacon, 15

SCALES, 13, 67  
 Scatter, 49  
 Screened loop, 38  
 Sense-finding, 25, 73, 82  
 Setting of scale, 14  
 Site for D/F station, 56  
 Skip distance, 49  
 Spaced open aerials, 9  
 Spacing error, 51  
 Stand-by position, 30  
 Swing bearing, 14

TRANSFORMER, shielded, 38  
 True bearings, 3  
 ——— north, location of, 57

VALVE-COUPLED open aerial, 30  
 Vertical error, 36

WAVE-FRONT, 6

ZERO-SHARPENING, 40

## FLIGHT WITHOUT FORMULAE

By A. C. KERMODE, B.A., F.R.Ae.S., M.I.Ae.S.

This is the ideal book for the beginner—a simple explanation of the main principles of aeroplane flight, thoroughly comprehensive, up to date, and correct, yet entirely without mathematical formulae. There are over 100 illustrations, including 24 full-page plates. 239 pp. 6s. net.

## THE AEROPLANE STRUCTURE

By A. C. KERMODE.

This book, like its companion volume, *Flight Without Formulae*, explains the subject without the aid of mathematical formulae. It is particularly suitable for those pilots and aircraft workers who wish to increase their efficiency through an improvement in their basic knowledge. 230 pp. 6s. net.

## MECHANICS OF FLIGHT

By A. C. KERMODE.

This popular book outlines the principles which maintain an aeroplane in flight. It is written in an interesting manner that is not too advanced to be understood by the average student. The avoidance of advanced mathematics, mechanics, and trigonometry has been observed throughout the text. 231 pp. 7s. 6d. net.

## THE ELEMENTS OF AERONAUTICS

By K. SCHUTT, Ph.D. Translated from the German by EDGAR REISSNER, B.Sc., and FRANK FLEETWOOD.

Invaluable to the air cadet, the mechanic, and the apprentice who wishes to understand the reasons underlying his daily work. With few exceptions, the many illustrations are of British or American aircraft. 186 pp., illustrated. 12s. 6d. net.

## BENNETT'S COMPLETE AIR NAVIGATOR

By WING-COMMANDER D. C. T. BENNETT, D.S.O.

Covers the syllabus for the Air Ministry First Class Air Navigator's Licence. Deals fully with astronomical navigation, air pilotage, and direction finding, wireless, together with a certain amount of calculation, and includes a most valuable chapter on Meteorology. 372 pp., illustrated. 15s. net.

## LEARNING TO FLY

By FRANK A. SWOFFER, M.B.E.

A standard guide for all who are taking flying lessons, as well as a useful source of reference to details of engine working and maintenance for pilots. 170 pp., illustrated. 7s. 6d. net.

PITMAN

## RADIO SIMPLY EXPLAINED

By FLYING OFFICER JOHN CLARRICOATS, A.T.C., *Secretary of the Radio Society of Great Britain*. The latest addition to Pitman's "Simply Explained" Series, giving a lucid explanation of the subject. Paper covers. 9d. net.

## A FIRST COURSE IN WIRELESS

By "DECIBEL." Gives a careful explanation of the fundamental principles of wireless, particular attention being paid to points which most frequently present difficulty. 221 pp. 5s. net.

## WIRELESS TERMS EXPLAINED

By "DECIBEL." Explains the meaning of every term in the fullest and clearest manner, with illustrations, providing additional information where necessary. 72 pp. 2s. 6d. net.

## RADIO RECEIVER CIRCUITS HANDBOOK

By E. M. SQUIRE. A useful guide to circuits in which the subject is dealt with by stages. Illustrated. 88 pp. 5s. net.

## AIRMEN'S MATHEMATICS

By M. J. G. HEARLEY, B.Sc., and R. LEVERINGTON SMITH, B.Sc., A.K.C. The best book for the purpose. One of the authors is in charge of Maths at an R.A.F. school, and the book is obviously the one you should have. 3s. 6d. net.

## RAPID NAVIGATION TABLES

By W. MYERSCOUGH and W. HAMILTON. An invaluable series of tables, complete with plotting card. Indispensable to every navigator, pilot and student of flying. 10s. 6d. net.

## NUMERICAL EXAMPLES IN ELEMENTARY AIR NAVIGATION

By G. K. CLATWORTHY, B.Sc. Enables students to gain the facility which in this type of work is so vital to quick and accurate computation under flying conditions. 3s. 6d. net.

Send for a Complete List of Pitman's  
Technical Books, post free, from  
Parker St., Kingsway, London, W.C.2